

JB - 304

Villa Video Door Entry System

User's Manual (v3.0)



Please read this manual carefully before the products are installed. Technical specifications and contents are subject to change accordingly without advance notification.

CONTENTS

	<i>Page</i>
Part 1. Product introduction	1~2
1.1 Use purpose	1
1.2 System configuration	1
1.3 Features and functions	2
Part 2. Technical parameters & structure	3~4
2.1 Technical parameters	3
2.2 Structure	3
Part 3. Installation and connection	5~11
3.1 Installation	5
3.2 Connection	7
Part 4. System programming	12~15
4.1 Audio jumper	12
4.2 Video resistor	12
4.3 Door station address	12
4.4 Card reader(for Model No.15&No.18 only)	13
4.5 Password (for Model No.18 only)	14
Part 5. Operation	16~19
5.1 Operation on door stations	16
5.2 Operation on indoor phones	16
Part 6. Troubleshooting	20
6.1 Test	20
6.2 Troubleshooting	20

Part 1. Product introduction

1.1 Use purpose

The system is applied to single family houses, offices, shops, warehouses, and other access control purpose.

1.2 System configuration

Configuration	Options	Remarks
Door station	Model No.6 Model No.9 Model No.15 Model No.18	①All panels are aluminum. ②Door stations don't require any direct power supply. ③Card reader is available on Model No.15 and No.18. ④Model No.9 door station is with a pinhole camera. ⑤Name tag is available on Model No.9 and No.15. ⑥There are options of the bracket (surface mount) and installation box (flush mount) for Model No.6 and No.15 door panels. ⑦Model No.18 is with a keypad for PIN codes to release doors.
Indoor phone	Model: F-7 Model: V-26 Model: N60 Model: N72B Model: N75B	① Model V-26: 4 or 4.3" TFT color screen. ② Model N60, N72B, and N75B: 7" TFT color screen. ③ Model F-7: Audio handsfree indoor phone. For economic purpose. ④ Every video indoor phone requires the 18VDC power.
Power supply	Adapter (18VDC, 1A) Transformer (18VDC, 2.2A)	①Both are free voltage input AC100V~240V. ②One transformer can support up to 4 video indoor phones while one adapter can support only one video indoor phone. But if there are 3 or more door stations, another transformer may be required.

⚠ We may provide more options and the current options may be replaced without advanced notification.

1.2.1 Door stations



Model No.6
94X138X38(mm)



Model No.9
54.5X140.5X40(mm)

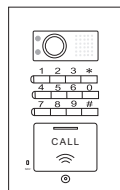

Model No.18
102X175X39(mm)

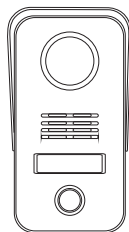

Model No.15A surface mount
79X148X45(mm)



Model No.15B surface mount,
card reader. 79X148X45(mm)

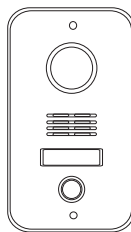

Model No.15C flush mount
93X168X52(mm)

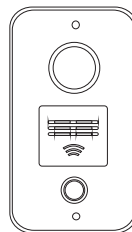

Model No.15D flush mount,
card reader. 93X168X52(mm)

1.2.2 Indoor phones

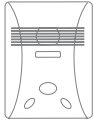

Model F-7
101X135X25(mm)

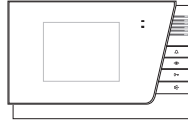

Model V-26
180X115X21(mm)



Model N60
239X139X20(mm)

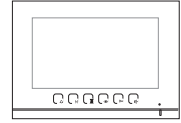

Model N72B
210X150X23(mm)



Model N75B
210X150X23(mm)

1.2.3 Power supply



Adapter

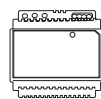

Transformer
(DIN Rail)

1.3 Features and functions

- > Call, answer, and release doors.
- > DIY system with 4 wires; PLUG & PLAY connection.
- > Various flexible connection diagrams are optional.
- > Max. capacity: Up to 4 door stations and 4 indoor phones.
- > Intercom and calling transfer between indoor phones.
- > Various melody ring tones are optional.
- > Two options to release doors, by SIGNAL or by POWER (Models except No.9).
- > Use two group passwords to release two doors and gates(Model No.18).
- > Double unlock buttons to release two doors/gates/garages...(Model N60, N72B, N75B).
- > Use cards to release the doors (Model No.15 & No.18).
- > Surface and flush mount are optional (Model No.6 and No.15).
- > Rainproof and anti-vandal (Model No.6, No.9, No.15 and No.18).
- > Night viewing; illuminated call button.
- > Touch button indoor phones are optional (Model N60, N72B, N75B).
- > Picture memory and privacy functions are available on Model N72B, N75B.

Part 2. Technical parameters & structure

2.1 Technical parameters

2.1.1 Door station

Camera:	1/3" SONY CCD or 1/3" CMOS
Viewing angle:	92°
Lens:	F=3.6
Resolution:	420TV Line
Min. illumination:	0.01 LUX
Video output:	1 Vp-p/75Ω
Audio SNR:	≥25dB
Audio distortion:	≤7%
Standby current:	≤60mA
Working current:	≤230mA
Working voltage:	DC18V±10%
Environment temperature:	-40°C ~+70°C

2.1.2 Indoor phone

Display:	4" TFT, 4.3" TFT, 7" TFT
Resolution:	420TV Line
Video output:	1 Vp-p/75Ω
Audio SNR:	≥25dB
Audio distortion:	≤7%
Standby current:	≤60mA
Working current:	≤500mA
Working voltage:	DC18V±10%
Environment temperature:	-10°C ~+55°C

2.1.3 Power supply

	Adapter	Transformer
Voltage input:	AC100V~240V	AC100V~240V
Voltage output:	DC18V	DC18V
Current output:	1A	2.2A
Power plug style:	Optional	/

2.2 Structure

2.2.1 Door stations

A) Model No.6:

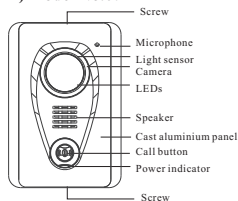

B) Model No.9:

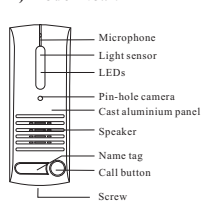

C) Model No.18 (Flush mount):

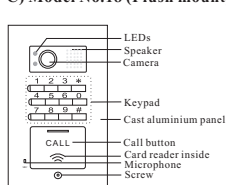

D) Model No.15 (Surface mount):

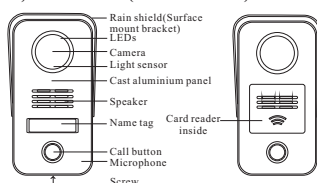

E) Model No.15 (Flush mount):

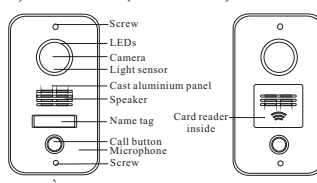

2.2.2 Indoor phones

A) Model F-7

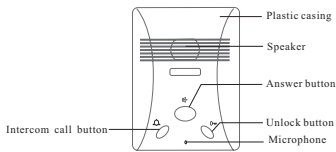

B) Model V-26

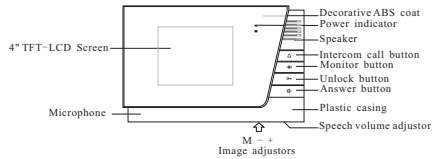

C) Model N60

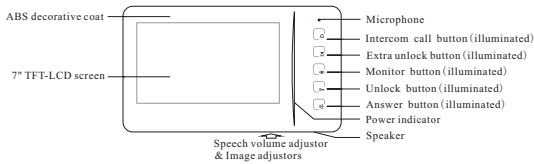

D) Model N72B

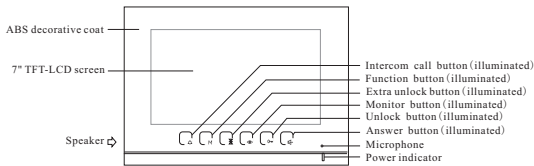

E) Model N75B

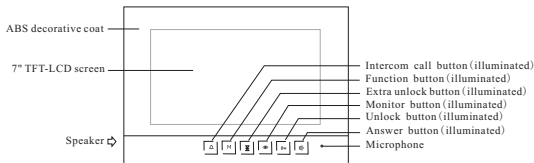

2.2.3 Power supply

A) Adaptor



B) Transformer

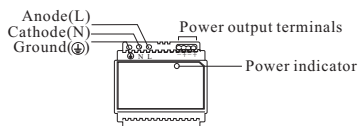

Part 3. Installation and connection

3.1 Installation

3.1.1 Door stations

Model No. 6

A) Surface mount

- Take off the coat from the door panel with the enclosed driver (①).
- Install the expansion plugs in the wall beside the cable(④).
- Put the big seal behind the bracket and fix both on the wall with the screws(③).
- Put the small seal behind the door panel and then fix both on bracket after connect the cable(②).
- Cover the door panel with the coat and fix them with the screws and driver(①).

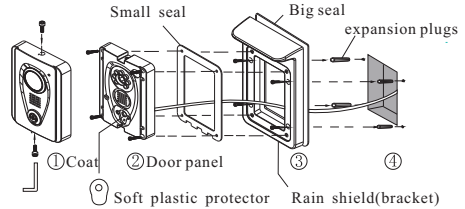

B) Flush mount

- Produce a groove (115x70x41mm) on a proper position in the wall(④).
- Put the box in the groove and fix it in the wall with screws and cement(③).
- Take off the coat from the door panel with the enclosed driver(①).
- Put the small seal behind the door panel and fix them on the box with screws after connect the cable(②).
- Cover the panel with the coat and fix it(①).

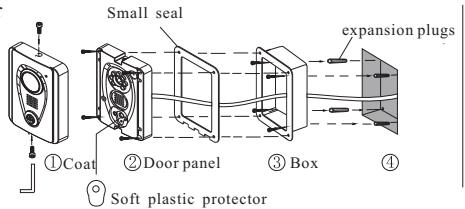

Please mind the soft plastic protector is put on the call switch. It is easy to drop.

Model No.9

- Release the panel from the bracket with the enclosed screw driver(②③).
- Choose a proper position and fix the big seal and bracket on the wall with 2 screws (①②).
- Put the panel on the bracket after connect the cable(③).
- Fix the panel from the bottom with the enclosed driver and screw(②③).

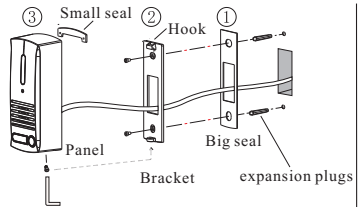

Model No.18 (Flush mount)

- Produce a groove(86.4x154.4x55mm) on a proper position of the wall(①).
- Take off the door panel from the box with the enclosed screw driver(②③).
- Fix the box in the groove with screws and expansion plugs or cement(①).
- Fix the door panel in the box with the screws(④).

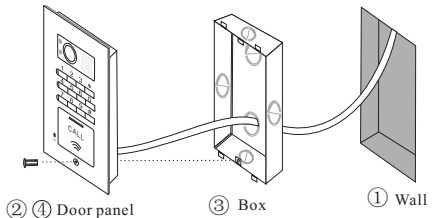

Model No.15

A) Surface mount

- Take off the door panel from the bracket with the enclosed screw driver(①).
- Fix the bracket on the wall with two screws and expansion plugs(②).
- Put the door panel on the bracket and fix it after connect the cable(③).

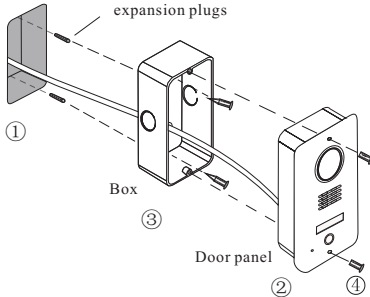
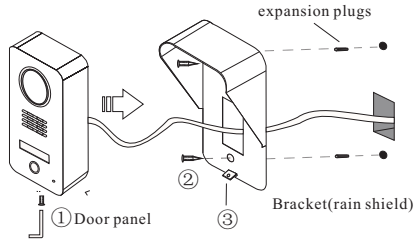

B) Flush mount

- Produce a groove (75x150x50mm) on a proper position of the wall(①).
- Take off the door panel from the box with the enclosed screw driver(②③).
- Fix the box in the groove with screws and expansion plugs or cement(①).
- Fix the door panel in the box with the screws(④).



- Mind the actual camera viewing angle and put the door station on a proper position. [the manufacturer suggests 1.4~1.8m of height.]
- Do not put the devices at the places where there are high voltage, high temperature, strong magnet, corrosive, humidification, etc.
- Do not drag the cable.
- Keep the devices clean.

3.1.2 Indoor phones

A) Audio indoor phones

- Take off the bracket by pushing the bracket and panel in contrary direction(①).
- Fix the bracket on the box or on the wall with screws(② or ③).
- Put the panel on the bracket and push it down until the panel is locked by the hooks(④).

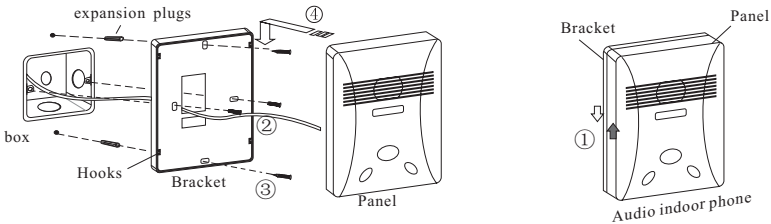

Audio and video indoor phones may have different sizes of bracket. Please install accordingly.

B) Video indoor phones

- Fix the bracket on the box or on the wall with the screws(① or ②).
- Move the indoor phone and put it on the bracket after connect the cable(③).

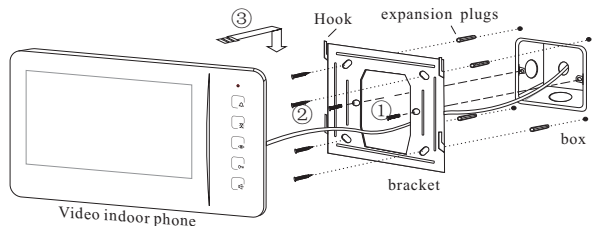

C) Magnetic type

- Fix the bracket on the box or on the wall with the screws(① or ②).
- Move the indoor phone and put it on the bracket after connect the cable(③).

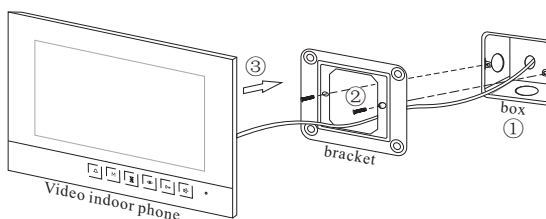

3.1.3 Name tag

A) Model No.9

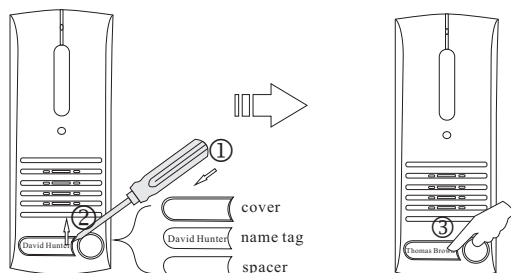

- Use a proper screw driver and insert it into the gap of the name tag and then turn it up(① ②).
- Change the name tag.
- Insert the set of name tag into the groove(③).

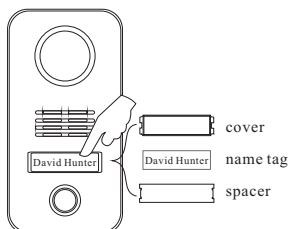

B) Model No.15



- Press the name tag at a side and then take it off.
- Change the name tag.
- Insert the set of name tag into the groove and then press it to be locked.

3.2 Connection

3.2.1 Wires and distance

Wires	Best distance	Remarks
 RVV4x0.5mm ² (U.S.:AWG20)	≤100m	Between the last door station and the last indoor phone
 RVV2x1.0mm ² (U.S.:AWG18)	≤100m	For DIN rail power supply (transformer)

3.2.2 Terminals

- ① ② Terminals to door station or/and indoor phone.
Both have no difference.
- ③ Terminal to power supply
- ④ Terminal for electronic POWER lock
- ⑤ Terminal for electronic SIGNAL lock
- ⑥ Door station address code wires
- ⑦ Electronic lock selector(jumper)
- ⑧ Audio jumper
- ⑨ Program button
- ⑩ Terminals for gates/garages/lights ...

A) Door stations

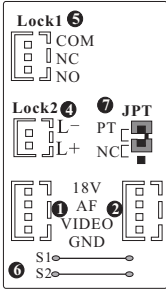

Model No.15

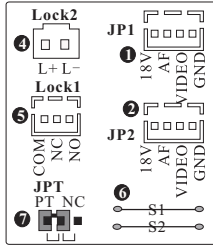

Model No.6

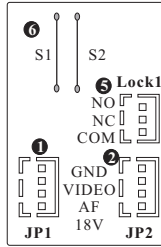

Model No.9

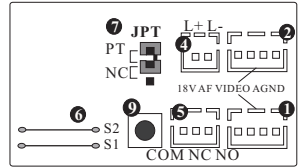

Model No.18

B) Indoor phones

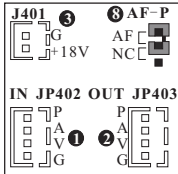

Model F-7

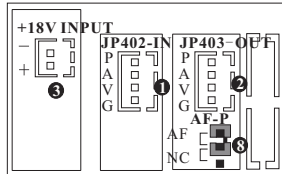

Model V-26

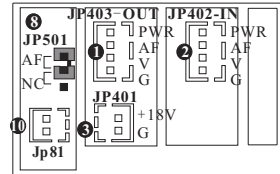

Model N60

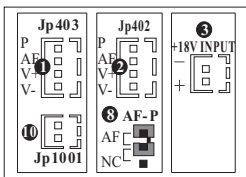

Model N72B & N75B

3.2.3 Component diagram

A. Basic connection

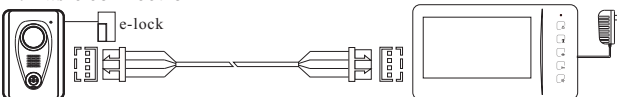

B. Best connection for up to 4 door stations and 4 indoor phones

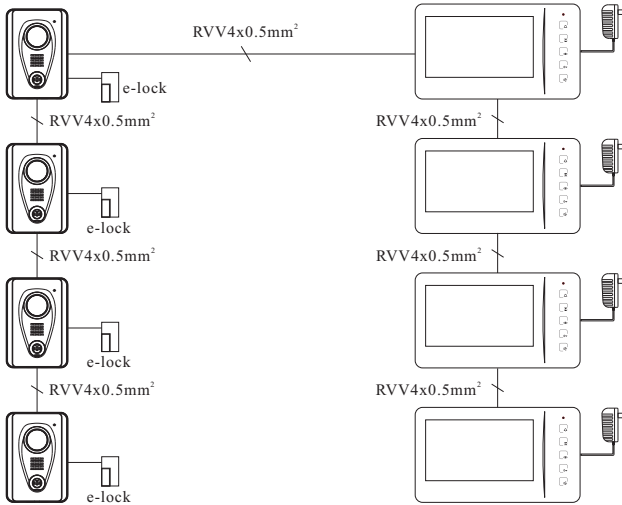

C. Other workable connection

C1. Example 1:

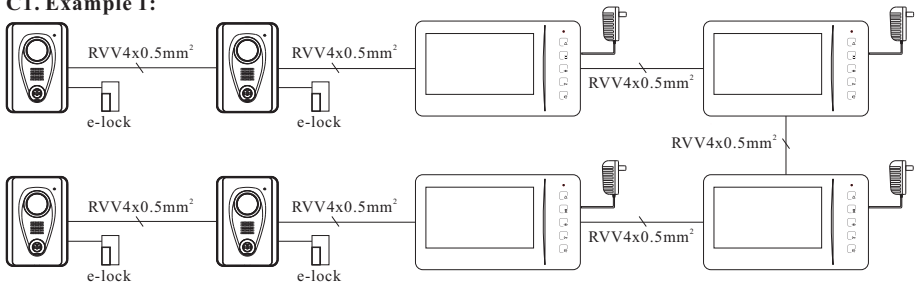

C2. Example 2:

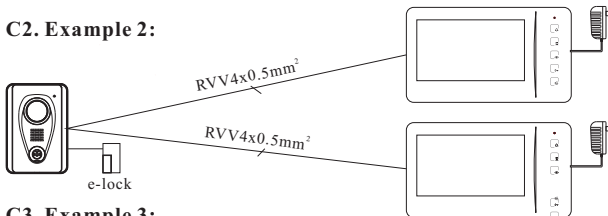

C3. Example 3:

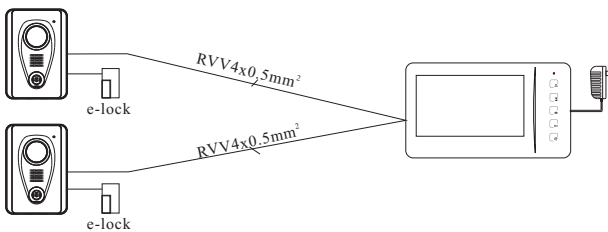



- ① The basic components are 1 door station, 1 indoor phone, and 1 power supply. The max. capacity the manufacturer suggests is 4 door stations and 4 indoor phones. More components may cause malfunctions.
- ② One adapter can support only one video indoor phone while one transformer can support up to 4 indoor phones. But if there are 3 or 4 door stations, one more adapter or transformer is required, because the turning monitor function may be not workable.
- ③ All door stations do not require power supply.
- ④ Audio indoor phones do not require independent power supply. They can share the same power supply with video indoor phone.
- ⑤ For easy connection the diagrams of C1, C2, and C3 can be applicable to projects accordingly.
- ⑥ Video resistors may be helpful in case there is any problem with image display especially while 2 or more video indoor phones are used. Please go to 4.2 for the resistors' usage.
- ⑦ When there are 2 or more door stations, the address wires have to be cut so that every door stations have their exclusive address codes. If there are, please go to 4.3 for door station address.
- ⑧ In case more indoor phones or door stations are required in diagram A, C1, C2, and C3, please connect them from the terminal wires and try. If the image quality is not good enough and the image adjustors cannot help, please read 4.2 and try accordingly.

3.2.4 Electronic locks

There are various electronic locks. People from different countries may have different practice of using electronic locks. Generally speaking there are two methods to release doors via door entry systems. One is SIGNAL. Another is POWER. This system supports both. Users may adopt either accordingly.

A) Diagrams for POWER electronic locks (example: Door station Model No.15)

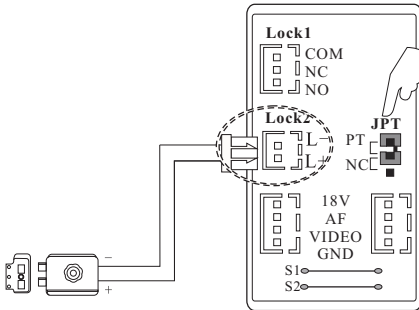

B) Diagrams for SIGNAL electronic locks (example: Door station Model No.15)

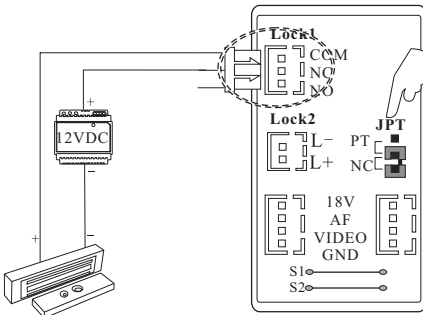

- ① Please choose one of the abovementioned diagrams according to the electronic locks.
- ② Instant output (Diagram A): 12VDC, 500mA.
- ③ Please put the jumper of JPT on PT position once you wire as diagram A. But please put it on NC position once you wire as diagram B.

- ④ In diagram B, COM terminal has to be connected. NC means close circuit. NO means open circuit. Please choose a right terminal according to the electronic locks.
- ⑤ There is no terminal for power locks on the door station Model No.9.
- ⑥ The electronic locks can keep releasing in 0.5 second only in diagram A, but in 5 seconds in diagram B.
- ⑦ It is available to release the electronic locks by directly pushing **0** button if the locks are connected to the indoor phones.
- ⑧ SIGNAL locks and POWER locks can be connected to different door stations or indoor phones. There is no interference.
- ⑨ A SIGNAL lock and a POWER lock can be connected to the same door station or the same indoor phone, but the jumper of JPT has to be put on PT position, so that the instant strong power current will not destroy the devices.
- ⑩ Please mind if the wires of electronic locks are nonpolarity.

3.2.5 Extra unlock button

There are extra unlock buttons with relays on Model N60, N72B, and N75B indoor phones. They can be applicable for gates, garages, lights, etc.

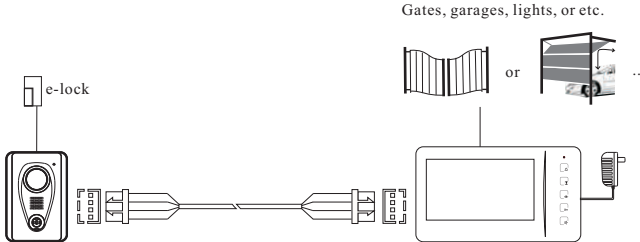

⚠ Caution!

Max. contact load (terminals ⑩ in 3.2.2): 2A/30VDC and 0.5A/125VAC.
DO NOT exceed the parameters. Otherwise it may cause damages.

Part 4. System programming

4.1 Audio jumper

The audio jumper has to be put on AF position in the indoor phone if there is only one indoor phone. In case there are more indoor phones, only the last indoor phone is required to do that. Meanwhile the other indoor phones' jumpers have to be put on NC position. Please do the same if there are two or more routes such as the diagrams of C1 and C2 in 3.2.3.

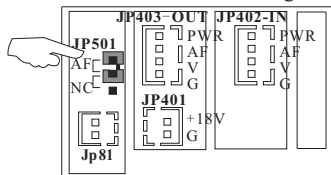

Video indoor phone(Model N60)

4.2 Video resistor

In case the image display is rolling or with any other abnormality problem and the image adjustors can not help, please try to use the enclosed video resistors to connect between GND (G) and Video (V) terminals in the last video indoor phone(s). *Either end can be connected to G or V.*

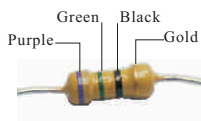

75Ω video resistor

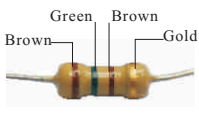

150Ω video resistor

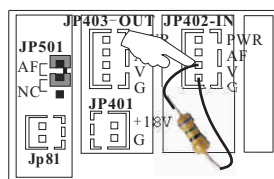

Video indoor phone (Model N60)

Diagram (3.2.3)	Video resistor size and quantity required
A	75Ω video resistor: 1 piece
B	75Ω video resistor: 1 piece
C1	150Ω video resistor: 2 piece Connect each on the two indoor phones that are closest to the door stations.
C2	150Ω video resistor: 2 piece Connect each piece on the two indoor phones separately.
C3	75Ω video resistor: 1 piece

4.3 Door station address

If there are two or more door stations, the door stations have to be addressed by cutting the code wires as the following table. The code wires are on the position ⑥ as 3.2.2 A and marked as S1 and S2.

Door station address No.	Code wire: S1	Code wire: S2
0 (1st door station)		
1 (2nd door station)		
2 (3rd door station)		
3 (4th door station)		

Please be sure every door station has exclusive address numbers if they work together.

4.4 Card reader (for Model No.15 & No.18 only)

A. Register master cards

The system provides up to 8 master cards. Users may use the card to register or cancel other cards easily.

- Push the program button in the back side of the door station with a tool(①).Release it when the door station sounds a beep.
- Push the CALL button and do not release it for 2 seconds(②). The door station will sound double beeps. At this moment the system gets ready to register master cards.
- Put a card proximate to the reader(③). When the door station sounds a beep, the card is registered as a master card successfully. If more master cards are needed, please continuously put more cards proximate to the reader one by one.
- Exit by pushing the program button again(①). (It also can exit automatically after 15 seconds.)

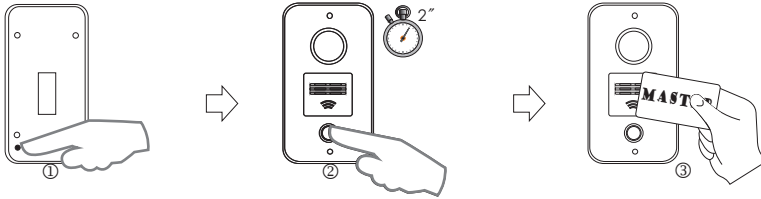

B. Register user cards

- Put a master card proximate to the reader(①). The reader will get ready to register user cards as soon as the door station sounds a long beep.
- Put a card proximate to the reader(②). The door station will sound a beep if it is registered as a user card successfully. *If more user cards are needed, please continuously put more cards proximate to the reader one by one. (Max. capacity: 120pcs)*
- Exit by putting the master card proximate to the reader again(①). (It also can exit automatically after 15 seconds.)

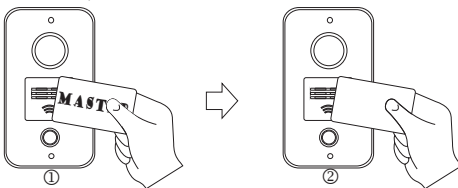

C. Cancel cards

- Put a master card proximate to the reader(①). The door station will sound a long beep.
- Push the CALL button and do not release it for 2 seconds(②). All registered user and master cards will be canceled as soon as the door station sounds a long beep again.

☺ Meanwhile the reader gets ready for registering master cards.

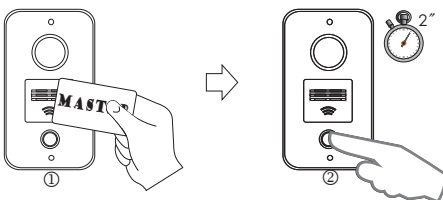

4.5 Password settings (for Model No.18 only)

Residents are allowed to use passwords to release the doors on the door station Model No.18. There are three group passwords. They are

> System password (default:1234). It is the key to change all passwords.

> Entry password 1 (default:1235). It is the key to open the doors that connect to the terminals of the door stations.

> Entry password 2 (default:1236). It is the key to open the gates that connect to the terminals of the indoor phones (extra unlock buttons on Model N60, N72B and N75B).

4.5.1 Get into the program status

Method 1>> Use the system password on the door station.

For example, push 1234 as the following figure.

Method 2>> Push the program button on the back side of the door station as the following figure.

The door station will sound a long beep to indicate the successful operation. Otherwise it will sound double beeps instead. It is same to 4.5.2.

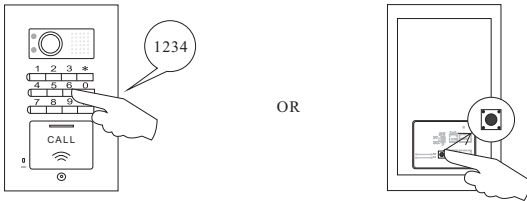

4.5.2 Change passwords

A) Change the system password

Step 1> Get into the program status as 4.5.1.

Step 2> Push *00*. If it sounds a long beep, then

Step 3> Push the new password and end by # button. If it sounds a long beep, then

Step 4> Repeat the new password and end by # button. If it sounds a long beep, the new password is valid.

For example, if the default password needs to be changed to 4444, then do as the following figures.

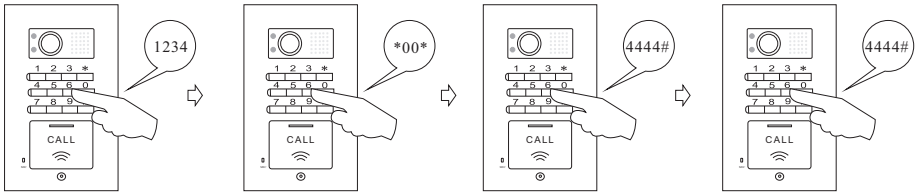

B) Change entry password 1

Step 1> Get into the program status as 4.5.1.

Step 2> Push *01*. If it sounds a long beep, then

Step 3> Push the new password and end by # button. If it sounds a long beep, then

Step 4> Repeat the new password and end by # button. If it sounds a long beep, the new password is valid.

For example, if the default password needs to be changed to 5555, then do as the following figures

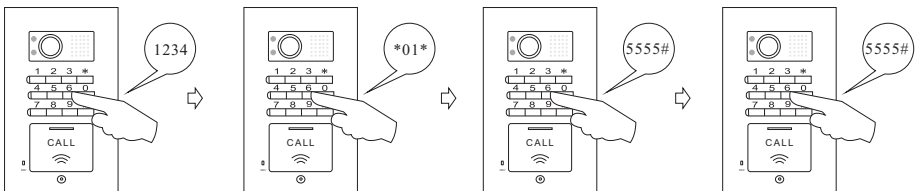

C) Change entry password 2

Step 1> Get into the program status as 4.5.1.

Step 2> Push *02*. If it sounds a long beep, then

Step 3> Push the new password and end by # button. If it sounds a long beep, then

Step 4> Repeat the new password and end by # button. If it sounds a long beep, the new password is valid.

For example, if the default password needs to be changed to 6666, then do as the following figures

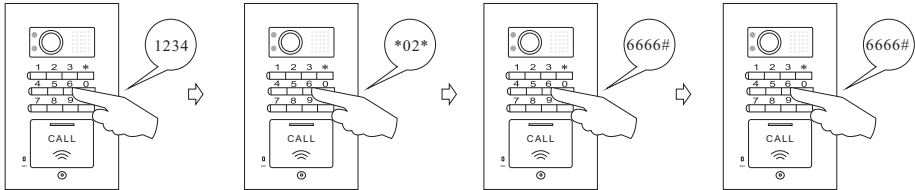

Ⓜ️ ① Before the door station exits the program status, the change can be tried again by repeating step 3 & 4 once the previous operation fails. ② The three group passwords should be exclusive to each other. ③ Entry password 1 is prior to Entry password 2. In case both are same, entry password 2 would be invalid, even if the change is successful. ④ The three group passwords can be set one by one at one time by starting from step 2, while the door station is on the program status.

4.5.3 Exit the program status

Method 1> Double push # button.

Method 2> Push the program button.

Method 3> Don't operate in 15 seconds.

4.5.4 Recall password

In case residents forget the passwords, please push the program button and then do the same as 4.5.2.

Part 5. Operation

5.1 Operation on door stations

5.1.1 Call residents

Push the CALL button on the door station. The door will sound a feedback ring if the calling is successful. The calling can be ended immediately once the call button is pushed again. If there is no answer, the calling will end itself after 15 seconds.

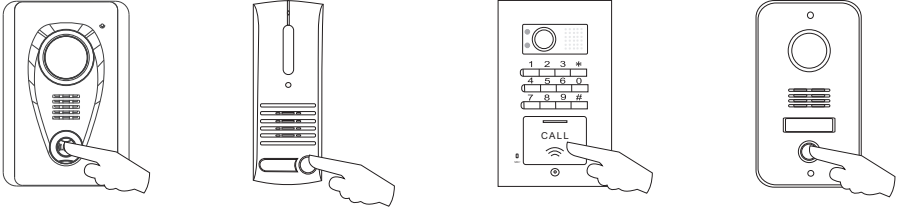

5.1.2 Use cards to release doors

Put a registered card proximate to the reader. The door station will sound a beep.

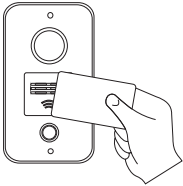

5.1.3 Use passwords to release doors

Push 4 digits password (e.g. 5555).



5.2 Operation on indoor phones

5.2.1 Answer

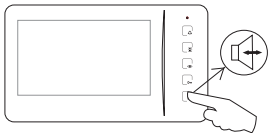

Push  button and speak.



5.2.2 Release door

Push  button while the indoor phone is at intercom status.



 The door can be released by pushing  button without calling if the electronic lock is connected to the indoor phone.

5.2.3 Release gates/garages ...

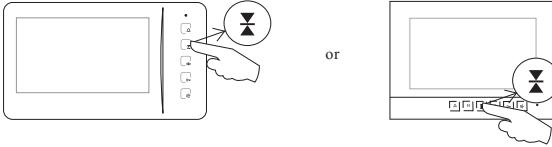

Push  button if the indoor phones are with the function.



5.2.4 Video surveillance

Push  button and then the image in front of the camera will be displayed on the screen.



 If there are two or more cameras, surveillance for different entrances is also available by a 2nd, 3rd, or 4th push. During surveillance it is available to speak with somebody outside by pushing  button and release the door by pushing  button.

5.2.5 Broadcast

Push  button and then speak. People nearby the other indoor phones can hear.



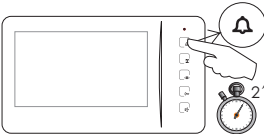

5.2.6 Call other indoor phones

Keep pushing  button for 2 seconds. The other indoor phones will ring.



5.2.7 Call transfer





Push  button to ring the other indoor phones while at intercom status. If somebody answers, the line will be transferred.

 Functions of 5.2.5, 5.2.6 and 5.2.7 are available only if there are two or more indoor phones.

5.2.8 Adjust the image quality

Push  button and then  button to keep displaying longer in order to get more time for operation.



   
Push MENU button, the screen will show CONTRAST, BRIGHTNESS AND COLOR by turn, then push + and - buttons to adjust their scales.

5.2.9 Change the ring tone

Keep pushing **0π** button for 2 seconds. The indoor phone will ring. Then continue to push the button again and again until the favorite ring sounds.

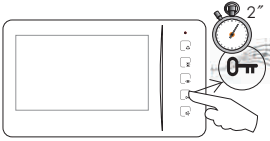

5.2.10 Adjust the ring & speech volume

Turn the wheel to decrease or increase the ring and speech volume.

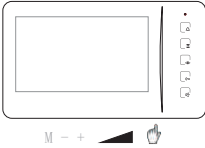

5.2.11 OSD menu and picture memory

5.2.11.1 Operation on OSD menu

Push **👁** button to activate the screen. Then push **M** button to activate the OSD menu. There are the items of brightness, contrast, color, language, date, time, and delete all. Users may push **0π** button (+) and **⏏** button (-) to adjust the parameters, and push **M** button to confirm or skip them.

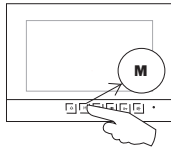
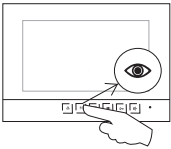

5.2.11.2 Picture memory

A. Capture images

The indoor phone will capture the visitor's image automatically if nobody answers the call after 3 seconds. *But the captured images will be canceled automatically if the call was answered at last.* Users also may push **👁** button to capture the image and store it during the communication.

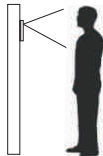
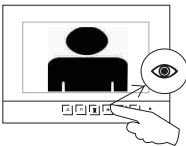



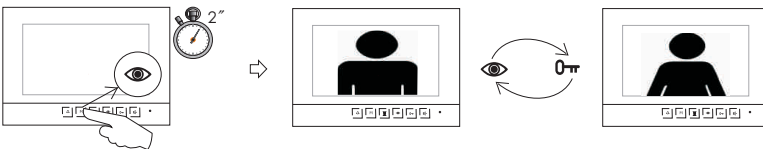

B. Review the stored images

Push **👁** button and do not release it for 2 seconds. The indoor phone will sound a double beep. The latest stored image will display. Users may push **👁** or **0π** buttons to turn the pages.





C. Delete the stored images

During the reviewing status push  button and do not release it for 2 seconds. The dialogue box will display. At this moment push  button again, then the viewing page will be deleted. Then push “ + ” buttons to exit.

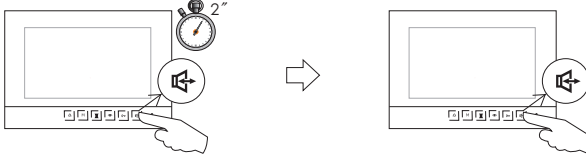
 In case all recorded images need to be canceled, users may go to the OSD menu (as 5.2.11.1).



5.2.11.3 Adjust ring and volume

Push  button and do not release it until the indoor phone rings. At this moment users may push  button again and again to choose the rings. The choice will be accepted once the indoor phone shuts automatically or the users push  button.

While adjusting users may push  button again and again to increase/decrease the ring volume.

There are 8 levels. The levels will turn to next one by one. The setting will quit itself if no operation in 10 seconds. Users also may push  button to confirm the setting and exit immediately.



5.2.11.4 Privacy setting

At the standby status push  button and do not release it for 2 seconds. The indoor phone will get ready for the privacy with a double beeps.

 The actions of pushing any button or answering a call, or the timeout (12 hours) will make the setting invalid.

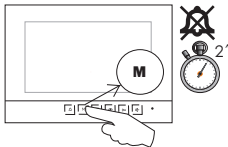

Part 6. Troubleshooting

6.1 Test

After all components are installed and connected as the user's manual, please switch the power on and then try to operate all features on all door stations and indoor phones as Part 5.

6.2 Troubleshooting

Common malfunctions	Possible reasons	Obviation
No feedback ring after pushing the call button. Meanwhile the door station's LED indicator doesn't turn on.	Disconnection on the power supply or socket.	Replace the power supply or the socket.
	Disconnection on the (red or black) signal wires.	Check and connect the wires.
No image displayed. The others are all ok.	Disconnection on the (black) signal wire of the indoor phone.	Check and connect the wires.
Poor image quality	No video resistor connected on the indoor phone.	Check and connect the video resistor.
	Wrong matched video resistor connected.	Replace the wrong video resistor with a correct one.
Receive a call but cannot answer.	Audio jumper is not on the right position (usually AF).	Use the audio jumper on the right position accordingly.
Ghost image.	No video resistor connected on the indoor phone.	Check and connect the video resistor.
	Two or more door stations share a same address.	Cut the code wires to make exclusive address no. for every door station.
Unavailable to activate a 2nd camera.	The power is too weak to support the whole system.	If use only one transformer, please add another transformer/adaptor.

