



BOB21M / **BOB2124E**

AUTOMATIONS FOR SWINGING GATES LINEAR WORM SCREWS

patented FACE gears
up to 2.1 m



CONTROL PANELS:

BOB21M ——— | BRAINY
HEADY

BOB2124E ——— | **BRAINY24**
HEADY24

BENINCA[®]
TECHNOLOGY TO OPEN
MADE IN ITALY



DESCRIPTION

Reliable, quiet, and quick to install geared motor, thanks to its 2 adjustable mechanical stops for opening and closing. Available in the 230 Vac and 24 Vdc versions. Rolled ball screws \varnothing 20 mm. Easy access release from above.

230 Vac

- Irreversible 230 Vac electromechanical geared motor

24 Vdc | intensive use

- Irreversible 24 Vdc electromechanical geared motor for intensive use, equipped with encoder
- The encoder device ensures maximum safety and precision in the gate moving phases
- Amperometric sensor obstacle detection system to prevent crushing
- Optional battery powered operation

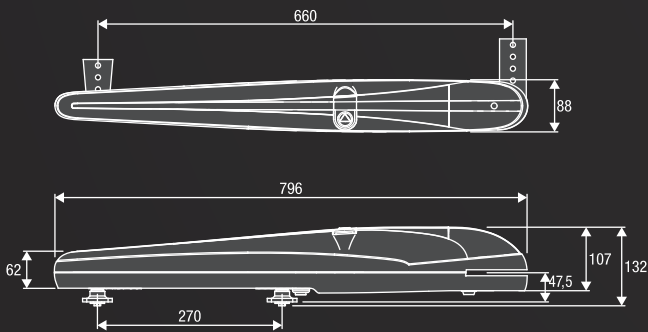

MEASURES

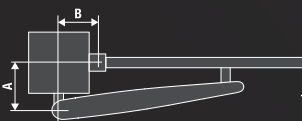

BOB21M / BOB2124E 105-135 115-135

COMPLETE KITS

KBOB21M 9592095

- 2 **BOB21M** 230 Vac Operators
- 1 **HEADY** 230 Vac control unit with integrated receiver
- 1 **PUPILLA.F** Pair of photocells
- 1 **LAMPI.LED** 230 Vac Led flashing light with built-in aerial
- 1 **TOKEY** Metal key selector
- 1 **TO.GO2WV** 433.92 MHz Transmitter

KBOB2124E 9592198

- 2 **BOB2124E** 24 Vdc Operators equipped with encoder device
- 1 **HEADY24** 24 Vdc control unit with integrated receiver
- 1 **PUPILLA.F** Pair of photocells
- 1 **LAMPI24.LED** 24 Vdc Led flashing light with built-in aerial
- 1 **TOKEY** Metal key selector
- 1 **TO.GO2WV** 433.92 MHz Transmitter





BOB.CS
9765040

Lock with personalized key and cover for BOB21M/BOB2124E unlock system.



B.SR
9819310

Multiposition brackets for one operator BOB21M/BOB2124E.



B.P
9819005

Screw-on plate for models in the BOB21 series.



DU.V96
9765035

12 Vac/dc vertical electric lock, supplied with counterplate. Permits internal/external release.



DU.V90
9765030

12 Vac/dc horizontal electric lock, supplied with counterplate. Permits internal/external release.



DU.9990
9623010

Covering plate for DU.V90.



E.LOCK
9765001

230 Vac vertical electric lock, supplied with counterplate.



E.LOCKSE
9765002

Extended cylinder for E.LOCK electric lock. It allows to unlock gates up to 55mm-thick from the outside.



CABLE.24E
9171002

Cable reel with 5 conductors (2 for motor, 3 for encoder) for connecting the encoder device in the 24 Vdc versions.

L= 100 m.



ID.TA
9846019

Warning board.



ESA BASIC
9176108

System that reduces the electrical energy consumption. In the 24 Vdc version, the use of ESA BASIC is not compatible with the battery operation.



KSUN
9611004

KIT for system operation via solar panel. For 24 Vdc models.

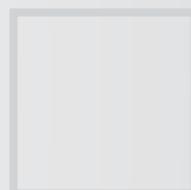
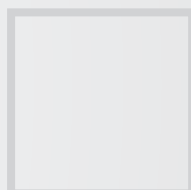
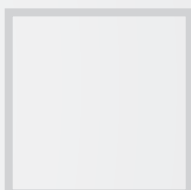
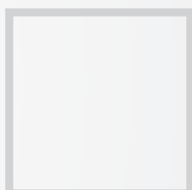
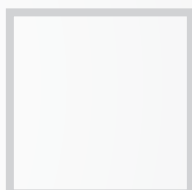

MADE IN ITALY

AUTOMATISMI BENINCA SpA • via del Capitello, 45 • 36066 Sandrigo (VI) ITALY • T +39 0444 751030 • F +39 0444 759728 • sales@beninca.it

TECHNICAL DATA	BOB21M	BOB2124E
Code	9591534	9591351
Power supply	230 Vac (50-60Hz)	230 Vac (50-60Hz)
Motor supply	230 Vac	24 Vdc
Max absorbed current	1.5 A	5.5 A
Max Thrust	1800 N	1800 N
Opening time	18"	9" - 21"
Operation cycle	30%	intensive use
Standard stroke	270 mm	270 mm
Max stroke	325 mm	325 mm
Protection level	IP44	IP44
Encoder	NO	YES
Operating temperature	-20°C /+50°C	-20°C /+50°C
Leaf max dimension	2.1 m	2.1 m
Weight	8.2 kg	8.2 kg
Items no. per pallet	54	54
Kits no. per pallet	18	18