



BOB50M / **BOB5024E**

AUTOMATIONS FOR SWINGING GATES LINEAR WORM SCREWS

patented FACE gears
full metal mechanics
gear and female screw in bronze
personalised release key
up to 5.0 m



CONTROL PANELS:

BOB50M ——— | BRAINY
HEADY

BOB50ME ——— | BRAINY

BOB5024E ——— | **BRAINY24**

BENINCA[®]
TECHNOLOGY TO OPEN
MADE IN ITALY



DESCRIPTION

Reliable, quiet, and quick to install geared motor, thanks to its 2 adjustable mechanical stops for opening and closing. Available in the 230 Vac and 24 Vdc versions. Rolled ball screws Ø 20 mm. Easy access release from above.

230 Vac

- Irreversible 230 Vac electromechanical geared motor
- Available in two versions: one with an easily adjustable limit switch (BOB50M) the other with encoder (BOB50ME)
- The encoder device in the BOB50ME version ensures crush prevention and precision in the gate moving phases

24 Vdc ^{intensive use}

- Irreversible 24 Vdc electromechanical geared motor for intensive use, equipped with encoder
- The encoder device ensures maximum safety and precision in the gate moving phases
- Amperometric sensor obstacle detection system to prevent crushing
- Optional battery powered operation

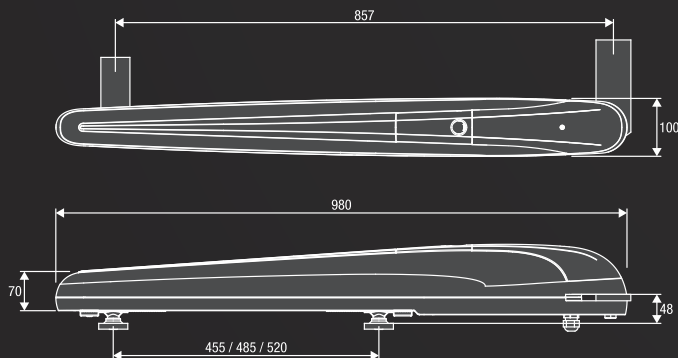

MEASURES

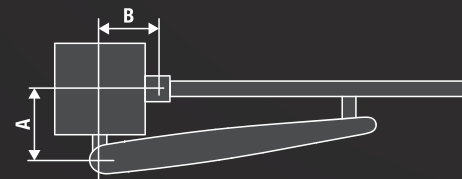

	A	B
BOB50M/E / BOB5024E	150-225	150-225



B.P
9819005

Screw-on plate for models in the BOB50 series.



DU.V96
9765035

12 Vac/dc vertical electric lock, supplied with counterplate. Permits internal/external release.



DU.V90
9765030

12 Vac/dc horizontal electric lock, supplied with counterplate. Permits internal/external release.



DU.9990
9623010

Covering plate for DU.V90.



E.LOCK
9765001

230 Vac vertical electric lock, supplied with counterplate.



E.LOCKSE
9765002

Extended cylinder for E.LOCK electric lock. It allows to unlock gates up to 55mm-thick from the outside.



CABLE.24E
9171002

Cable reel with 5 conductors (2 for motor, 3 for encoder) for connecting the encoder device in the 24 Vdc versions.

L= 100 m.



ID.TA
9846019

Warning board.



ESA BASIC
9176108

System that reduces the electrical energy consumption. In the 24 Vdc version, the use of ESA BASIC is not compatible with the battery operation.



KSUN
9611004

KIT for system operation via solar panel. For 24 Vdc models.

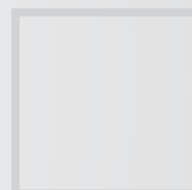
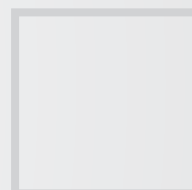
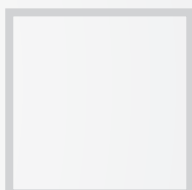
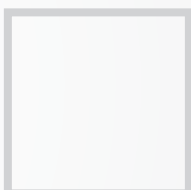
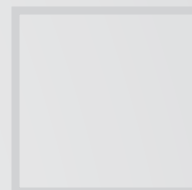
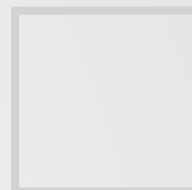

MADE IN ITALY

AUTOMATISMI BENINCA SpA • via del Capitello, 45 • 36066 Sandrigo (VI) ITALY • T +39 0444 751030 • F +39 0444 759728 • sales@beninca.it

TECHNICAL DATA	BOB50M	BOB50ME	BOB5024E
Code	9591022	9591023	9591328
Power supply	230 Vac (50-60Hz)	230 Vac (50-60Hz)	230 Vac (50-60Hz)
Motor supply	230 Vac	230 Vac	24 Vdc
Max absorbed current	1.4 A	1.4 A	6.7 A
Max Thrust	3500 N	3500 N	2200 N
Opening time	26"	26"	21"
Operation cycle	30%	30%	intensive use
Standard stroke	455 mm	455 mm	455 mm
Max stroke	520 mm	520 mm	520 mm
Protection level	IP44	IP44	IP44
Encoder	NO	YES	YES
Operating temperature	-20°C /+50°C	-20°C /+50°C	-20°C /+50°C
Leaf max dimension	5.0 m	5.0 m	5.0 m
Weight	11.6 kg	11.6 kg	11.6 kg
Items no. per pallet	40	40	40