



BULL8M



CONTROL PANELS:

BULL8M ————| CP.BULL8-OM

BULL8M.S ————| CP.BULL8-OM



## AUTOMATIONS FOR SLIDING GATES RESIDENTIAL USE

control with built-in encoder and receiver  
personalised release key  
**up to 800 kg**



### 230 Vac

- Electromechanical 230 Vac geared motor with built-in control unit and encoder
- The encoder device ensures crush prevention and precision in the gate moving phases
- Full metal release system
- Version with magnetic limit switches available (BULL8M.S)

#### BULL.P3

Raised foundation plate included.  
Floor fixing distance 260 x 117, no. 4 Ø 11,  
motor fixing distance 300 x 75 no. 4

### ■ COMPLETE KITS

#### KBULL8M 9592097

- 1 BULL8M 230 Vac Operator with control unit and built-in receiver
- 1 PUPILLA.F Pair of photocells
- 1 LAMPI.LED 230 Vac Led flashing light with built-in aerial
- 1 TOKEY Metal key selector
- 1 TO.GO2WV 433.92 MHz Transmitter

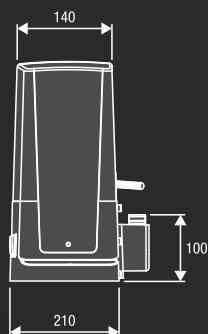
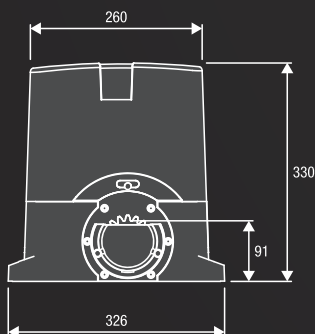



**RI.M4F**  
9272010

M4 rack 30x12x1000mm slotted and galvanized. Supplied with M6 metric screws and threaded spacers.

**Packaging: 4 pcs**



**RI.M4Z**  
9272030

M4 galvanized rack (22x22x2000 mm).

**Packaging: 2 pcs**



**RI.M4P**  
9272020

M4 Nylon rack with steel core, 28x40x1000 mm. Slotted, supplied with self-drilling screws.

**Packaging: 10 pcs**



**SB.BULL8.F**  
9747025

Externally fitted anti-intrusion cable unlock device (L=4.5m).



**ID.TA**  
9846019

Warning board.



**ESA BASIC**  
9176108

System that reduces the electrical energy consumption.

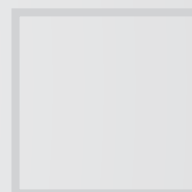
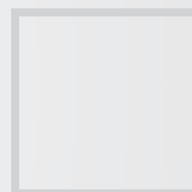
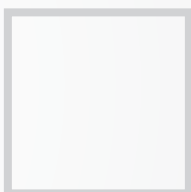
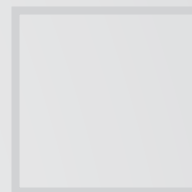
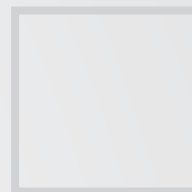

**MADE IN ITALY**

AUTOMATISMI BENINCA SpA • via del Capitello, 45 • 36066 Sandrigo (VI) ITALY • T +39 0444 751030 • F +39 0444 759728 • sales@beninca.it

TECHNICAL DATA	BULL8M	BULL8M.S
Code	9591522	9591524
Power supply	230 Vac (50-60Hz)	230 Vac (50-60Hz)
Motor supply	230 Vac	230 Vac
Max absorbed current	2.6 A	2.6 A
Max Thrust	940 N	940 N
Opening speed	10.5 m/min	10.5 m/min
Operation cycle	30%	30%
Protection level	IP44	IP44
Magnetic limit switches	<b>NO</b>	<b>YES</b>
Operating temperature	-20°C /+50°C	-20°C /+50°C
Max gate weight	800 kg	800 kg
Driving gear for rack	M4 Z18	M4 Z18
Weight	11.4 kg	11.4 kg
<b>Items no. per pallet</b>	<b>36</b>	<b>36</b>
<b>Kits no. per pallet</b>	<b>30</b>	<b>-</b>