



BULL15M



CONTROL PANELS:

BULL15M ———— | CP.BULL-RI

BULL15M.S | CP.BULL-RI



AUTOMATIONS FOR SLIDING GATES COMMERCIAL USE

control with built-in encoder and receiver
personalised release key
up to 1,500 kg



230 Vac

- 230 Vac geared motor with built-in control unit and encoder
- The encoder device ensures crush prevention and precision in the gate moving phases
- Self-ventilating for increased usage intensity
- Version equipped with magnetic limit switches available (BULL15M.S)

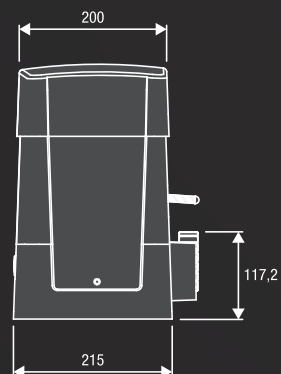
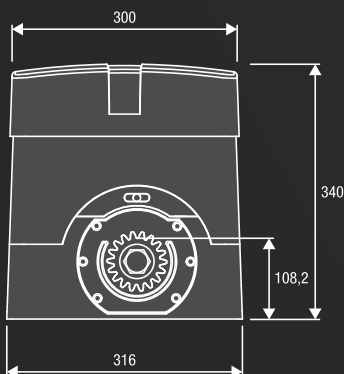



RI.M4F
9272010

M4 rack 30x12x1000mm slotted and galvanized. Supplied with M6 metric screws and threaded spacers.

Packaging: 4 pcs



RI.M4Z
9272030

M4 galvanized rack (22x22x2000 mm).

Packaging: 2 pcs



RI.M6Z
9272040

M6 galvanized rack 30x30x2000 mm. (needs the RI.P6 accessory to work).



RI.P6
9630001

M6 gear, It needs the rack RI.M6Z.



BULL.PI
9623005

Raised foundation plate. 280 x 170, n.4 Ø 11 floor brackets, 269 x 106 n.4 M10 screws for motor.



SB.BULL20.F
9747026

Externally fitted anti-intrusion cable unlock device (L=4.5m).



ID.TA
9846019

Warning board.



ESA BASIC
9176108

System that reduces the electrical energy consumption.

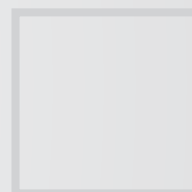
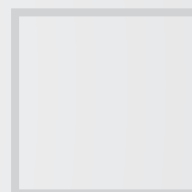
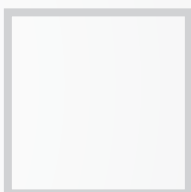
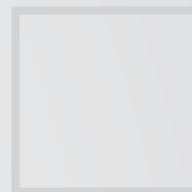
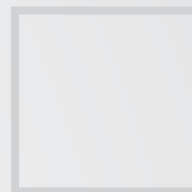

MADE IN ITALY

AUTOMATISMI BENINCA SpA • via del Capitello, 45 • 36066 Sandrigo (VI) ITALY • T +39 0444 751030 • F +39 0444 759728 • sales@beninca.it

TECHNICAL DATA	BULL15M	BULL15M.S
Code	9590576	9591017
Power supply	230 Vac (50-60Hz)	230 Vac (50-60Hz)
Motor supply	230 Vac	230 Vac
Max absorbed current	2.5 A	2.5 A
Max Thrust	1250 N	1250 N
Opening speed	10.5 m/min	10.5 m/min
Operation cycle	60%	60%
Protection level	IP44	IP44
Magnetic limit switches	NO	YES
Operating temperature	-20°C /+50°C	-20°C /+50°C
Max gate weight	1500 kg	1500 kg
Driving gear for rack	M4 Z18	M4 Z18
Weight	20.1 kg	20.1 kg
Items no. per pallet	20	20