



CONTROL UNIT
INSTALLATION AND OPERATION MANUAL

pag. 10

LOG-BC



1. INTRODUCTION	11
2. MAIN FEATURES	11
3. TECHNICAL SPECIFICATIONS	11
4. SAFE INSTALLATION	12
5. POWER	12
5.1 M3 MOTOR + POWER SUPPLY 24 Vac	12
6. INPUT AND OUTPUT CONNECTIONS AND FUNCTIONS	12
6.1 M1 POWER TERMINAL BLOCK	12
6.2 M2 INPUTS CONTROL TERMINAL BLOCK	13
7. DIP-SWITCH CONFIGURATION	13
8. PROGRAMMING	13
8.1 PRELIMINARY CHECKS	13
8.2 CHAIN HEIGHT ADJUSTMENT	13
9. SETTING THE TRIMMERS	14
10. RADIO RECEIVER	14
10.1 RECEIVER TECHNICAL SPECIFICATIONS	14
10.2 RADIO CHANNEL FUNCTIONALITY	14
10.3 ANTENNA INSTALLATION	14
10.4 MANUAL PROGRAMMING	14
10.5 SELF-LEARNING MODE PROGRAMMING	14
11. WORKING WITH A BUFFER BATTERY	16
12. TROUBLESHOOTING GUIDE	16
13. ATTENTION	16

1. INTRODUCTION

The control unit denominated LOG-BC is designed to manage the PRIVÉE automation and is equipped with encoder input for learning the stroke and recognising the obstacle.
Thanks to the considerable amount of logic available even very particular operating conditions on systems can be met.

2. MAIN FEATURES

- Microprocessor logic
- Green LEDS displaying the status of the N.O. control inputs and red LEDS for the status of the N.C. safety ones
- Pull out terminal blocks
- Output for a flashing light and gate open indicator or for a red and green traffic light
- Integrated radio receiver 433Mhz; 2048 codes

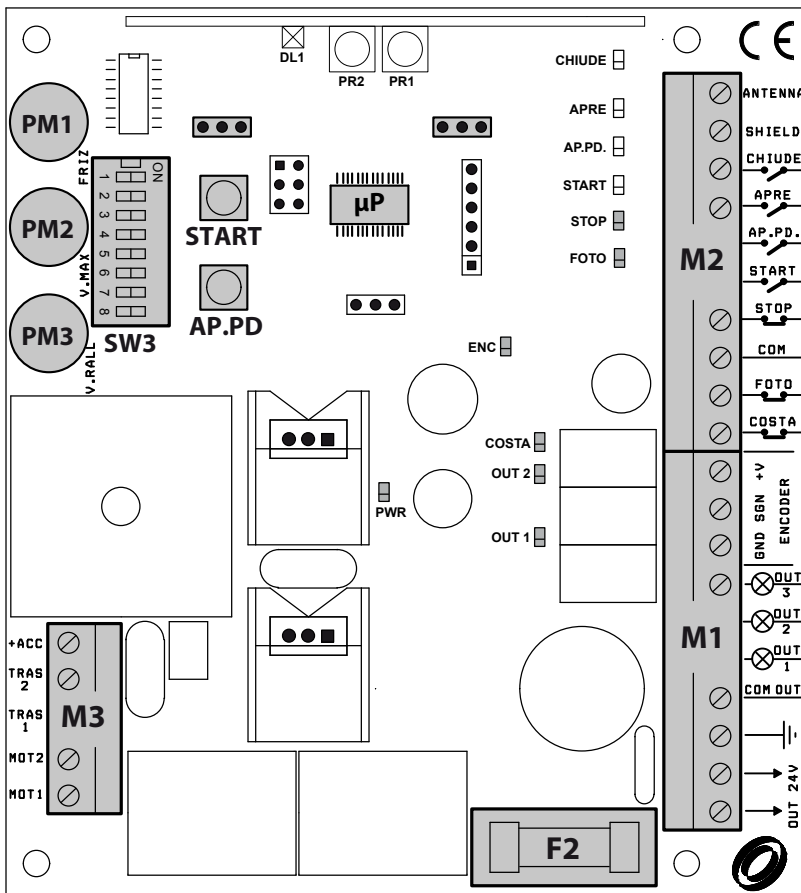

- M1:** Power terminal board
- M2:** Controls and safety devices terminal board
- M3:** Motor terminal, transformer, +acc
- SW3:** 8-way Dip Switch
- F2:** Power fuse 500mA 5x20
- AP.PD:** Semi-automatic opening cycle
- START:** Start and programming
- PM1:** Pre-manoeuvre warning lamp flash time
- PM2:** Chain dip
- PM3:** Pause time
- µP:** Microprocessor with flash memory

3. TECHNICAL SPECIFICATIONS

- Power: 230Vac ±10% 50/60 Hz 100W
- SCA output: 24Vac 3 W
- Flashing lamp output: 24Vac 25Wmax
- Power supply output for accessories: 20 ÷ 26 Vac 12W max.

4. SAFE INSTALLATION



In order to reach the level of safety required by current standards, read the following prescriptions carefully.

- 1) Do all the connections on the terminal block, reading the instructions given in this manual carefully and observing the general code of practice regulating the execution of electrical installations.
- 2) Install a four-pole circuit breaker upstream from the installation with a minimum contact opening distance of 3 mm.
- 3) Install, wherever it is not foreseen, a differential switch with a 30 mA threshold.
- 4) Check effectiveness of the earthing system and connect to it all parts of the automation that have a terminal or earth wire.
- 5) There must be at least one signalling device outside, either a traffic light type or a flashing light, together with either a danger or warning sign.
- 6) Apply all the safety devices required by the type of installation, considering the risks it can cause.
- 7) Separate the power lines (min. 1,5 mm² cross section) from the low voltage signal lines (min. 0,5 mm² cross section) in the ducts.
- 8) Jumper the unused NC inputs.
- 9) Arrange in series any contacts to be connected to the same NC input.
- 10) Arrange in parallel the inputs connected to the same NO input.
- 11) Keep radio control or other control devices out of children's reach, in order to avoid any unintentional automation activation.

5. POWER

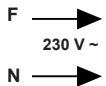

230V LINE

- Transformer input at 230V 50/60Hz
- Connect the earthing pole in the relevant terminal.
- Power the gear motor via the 3-way terminal protected by 1A fuse (5x20).
- Utilise an H07RN-F 2x1.5+T min type cable

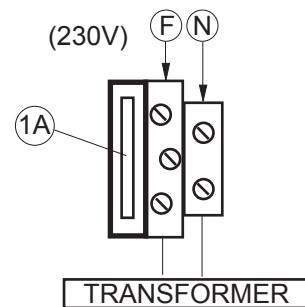

5.1 **M3** MOTOR + POWER SUPPLY 24 Vac

MOT1 - MOT2

Motor output 24Vdc. After a power failure, the first action performed is an opening cycle.

If it fails, stop the automation, take the motor connector out and put it back in the other way around.

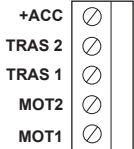

TRAS1 - TRAS2

24 Vac input for transformer. Connection to the control unit is shown in the figure here

+ACC

Do not use

6. INPUT AND OUTPUT CONNECTIONS AND FUNCTIONS

6.1 **M1** POWER TERMINAL BLOCK



OUT 24V

Accessories power supply (max 12 W):

24 Vac operations with mains power on.

24 Vdc (out+, 24V-) operation with no main power and optional buffer battery kit. KIT-BATT-SC



SCA 24Vac 3W max

Carriageway open LED that flashes slowly during opening, rapidly during closing, remains lit steady during the stop and pause phase and switches off when the barrier is closed.

N.B.: The indicator lamp flashes twice to indicate that the automation system has detected an obstacle three consecutive times while closing. Automatic closing is temporarily disabled and is enabled again only after a subsequent successful closing cycle.



YELLOW FLASHING LAMP (SL-R-24V-AI) 24Vac 25W max.

Flashing output for self-flashing blinker



NOT USED

6.2 M2 INPUTS CONTROL TERMINAL BLOCK

	FOTO Safety input with NC contact. During closure, when the photocell ray is interrupted, it immediately opens the gate again. If this input is kept open by a clock or weekly timer, the automation system closes again after the pause time, if programmed, and only once the entrance is clear.
	STOP NC safety input. When this is activated it stops the automation instantly and when a start command is then given the gate will always open. If a stop command is given during pause time it eliminates automatic re-closing, waiting for a command.
	START NO input, allowing the open and close signals to be sent to the automation system. This input is ignored during the opening cycle. If this input is commanded continuously, the automation system performs the opening cycle and, if the pause time is programmed and only once the entrance is clear, the automatic closing cycle.
	AP.PD. The command is accepted only if the barrier is completely closed, and automatic closing is temporarily disabled during the opening cycle. Use in accordance with the automatic logic of the start command (DIP 1-2 ON).
	APRE Encoder input SGN-2.
	CHIUDE NO input for closing. To close the automation only if the safety devices have not triggered.

7. DIP SWITCH CONFIGURATION

Dip switches 1 and 2: They select the functioning logic

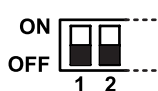

Off-Off: Hold-to-run logic.

The automation works by keeping the commands pressed, acting on the open or close inputs. The start command opens once and closes once. *Commands via radio in the hold-to-run logic are forbidden by law.*

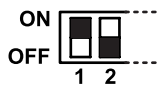

On-Off: SEMI-AUTOMATIC (Logic for pulse type collective control)

Open command only. To close after opening, press start or close. Pressing during closing cycle reopens the barrier.

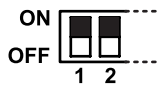

On-On: AUTOMATIC (Logic for pulse type collective control)

Open command only. Pressing start when paused closes barrier, pressing while barrier is closing opens barrier. Barrier is closed after pause time.

Dip switch 3: Selects pre-flashing function.

Off: The pre-flashing function is disabled: the flashing unit is commanded during the manoeuvre.

On: The warning lamp flashes for a period from 2 to 10 seconds (settable from trimmer PM1) before all manoeuvres except barrier inversion triggered by the safety devices.

8. PROGRAMMING

8.1 PRELIMINARY CHECKS

To guarantee the safety of the system, remember that the automation must be checked according to the risk analysis, therefore the installer must install any safety accessories needed and resolve all residue risks and dangers that the machine may cause when it works automatically via the remote controls.

8.2 CHAIN HEIGHT ADJUSTMENT

- 1) Switch automation system off and on.
- 2) Set trimmer PM2 (chain dip setting) to the middle setting.
- 3) Press start and wait. The automation system performs the reset procedure.
- 4) At the end of the reset procedure, press START again and wait for the closing cycle to conclude.
- 5) Adjust trimmer PM2 to set the desired chain height and perform an open cycle and a close cycle to check that the height is correct.

9. SETTING THE TRIMMERS

PM1: PRE-MANOEUVRE WARNING LAMP FLASH TIME. Sets the pre-manoeuvre warning flash time between 2 and 10 sec.

PM2: CHAIN DIP. Sets chain height. Turn clockwise to increase height.

PM3: PAUSE TIME. Sets the pause time between 2 and 120 sec.

10. RADIO RECEIVER

10.1 RECEIVER TECHNICAL SPECIFICATIONS

- Max. n° of radio transmitters that can be memorized:	64
- Frequency:	433.92MHz
- Code by means of:	Rolling-code algorithm
- N° of combinations:	4 billion

10.2 RADIO CHANNEL FUNCTIONALITY

Channel 1: START command
Channel 2: AP.PD command (Semi-automatic opening cycle)

10.3 ANTENNA INSTALLATION

Use an antenna tuned to 433MHz. Connect the tuned antenna to the antenna terminals using RG58 coaxial cable .

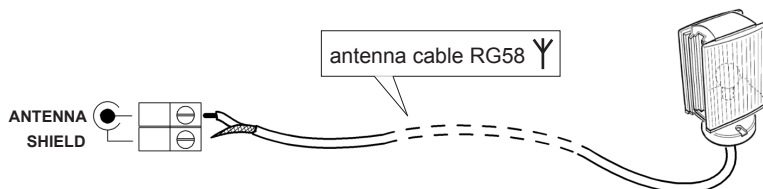

10.4 MANUAL PROGRAMMING

In the case of standard installations where no advanced functions are required, it is possible to proceed to manual storage of the transmitters, making reference to programming table A and to the example for basic programming.

- 1) If you wish the transmitter to activate output 1, press pushbutton PR1, otherwise if you wish the transmitter to activate output 2, press pushbutton PR2.
- 2) When LED DL1 starts blinking, press hidden key on the transmitter, LED DL1 will remain continuously lit.
- 3) Press the key of the transmitter to be memorized, LED DL1 will flash quickly to indicate that it has been memorized successfully. Flashing as normal will then be resumed.
- 4) To memorize another transmitter, repeat steps 2) and 3).
- 5) To exit memorizing mode, wait for the LED to go off completely or press the key of a remote control that has just been memorized.

IMPORTANT NOTE: ATTACH THE ADHESIVE KEY LABEL TO THE FIRST MEMORISED TRANSMITTER (MASTER).

In the case of manual programming, the first transmitter assigns the key code to the receiver; this code is necessary in order to carry out subsequent cloning of the radio transmitters.

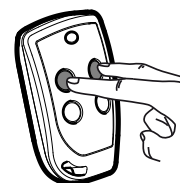

Hidden key

10.5 SELF-LEARNING MODE PROGRAMMING

This mode is used to copy the keys of a transmitter already stored in the receiver memory, without accessing the receiver.

The first transmitter is to be memorised in manual mode (see paragraph 10.4).

- a) Press hidden key on the transmitter already memorised.
- b) Press key T on the transmitter already memorised, which is also to be attributed to the new transmitter.
- c) Within 10 s., press hidden key on the new transmitter to be memorised.
- d) Press key T to be attributed to the new transmitter.
- e) To memorise another transmitter, repeat the procedure from step (c) within a maximum time of 10 seconds, otherwise the receiver exits the programming mode.
- f) To copy another key, repeat from step (a), having waited for the receiver to exit the programming mode (or after disconnecting the receiver from the power supply).

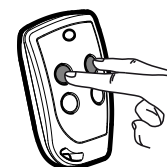

Hidden key

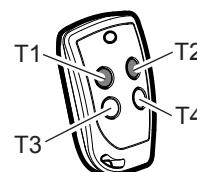
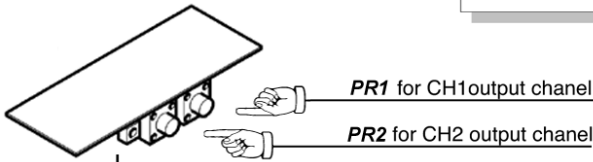











TABLE A





















When pressing the key PR1 (for channel 1) or PR2 (for channel 2) for the first time, the receiver sets to the programming mode. Every time the key PR is pressed after that, the receiver switches to the configuration for the subsequent function, that is indicated by the number of flashings (see table). At this stage, after selecting the channel (PR1 or PR2) and the desired function, the key T (T1-T2-T3 or T4) of the transmitter will be stored in the memory of the receiver as indicated in the table for programming.



Standard Programming

<p>Programming</p> 	<p>Constant blinking.     ...</p> <p>You will exit programming mode if no memorizing is performed for 10 s.</p>	<p>Press the hidden key on the transmitter until the LED remains lit, then press the T key (1-2-3 or 4) on the transmitter until it starts flashing again, wait for the LED to go off or switch off the power. The transmitter's T key is now memorized.</p>
<p>Automatic memory storage only transmitter with impulse output</p> 	<p>2 blinks followed by a pause of about 1 second.     ...</p> <p>The key T1 of the transmitter is automatically stored on the output CH1 while the key T2 on CH2.</p>	<p>Press the hidden key on the transmitter until the LED remains lit, then press key T1 on the transmitter (if other keys are pressed, they are ignored) until it starts flashing again, wait for the LED to go off (10 s.) or transmit a key to exit. T1 and T2 are now automatically memorized on CH1 and CH2.</p>

Advanced Programming

<p>Step-by-step output</p> 	<p>3 blinks followed by a pause of about 1 second.     ...</p> <p>N.D.</p>	<p>Non-associated function</p>
<p>Timer output</p> 	<p>4 blinks followed by a pause of about 1 second.     ...</p> <p>N.D.</p>	<p>Non-associated function</p>
<p>Code elimination</p> 	<p>5 blinks followed by a pause of about 1 second.     ...</p> <p>N.D.</p>	<p>Non-associated function</p>
<p>Cancellation of the entire receiver memory</p> 	<p>6 blinks followed by a pause of about 1 second.     ...</p> <p>WARNING! This operation deletes all of the radiocontrols stored on channel 1 and channel 2 from the memory of the receiver.</p>	<p>While the LED is flashing, keep buttons PR1 and PR2 on the receiver held down together for longer than 10 sec. The LED flashes very quickly. By the time the LED goes off, all the transmitters are deleted and you exit programming mode.</p>

LEGEND

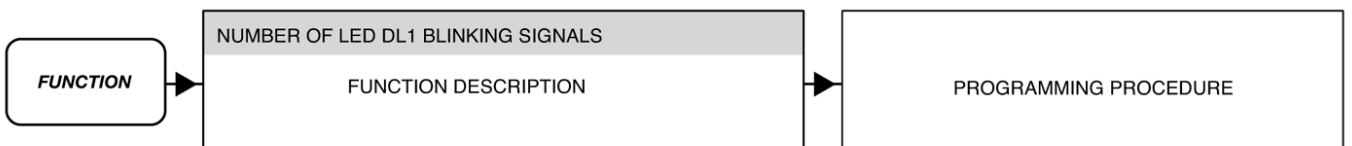

11. WORKING WITH A BUFFER BATTERY

KIT-BATT-SC allows the automation system to operate even when the mains power supply is disconnected for a short time. Consult the KIT-BATT-SC installation manual.

12. TROUBLESHOOTING GUIDE

1) The chain drops by a few centimetres at the end of the close cycle.

At the end of the first close cycle, the control unit determines the force necessary to be applied with the electronic brake and the excessive dip will be compensated when subsequent close cycles are performed.

2) The barrier is reopened by the automation system during a close cycle, even though there are no obstacles and the photocell beams are not interrupted.

The chain height setting is too high. Reduce the setting with trimmer PM2.

13. ATTENTION

You are recommended to fulfil an installation that includes all the accessories required to guarantee operation according to current standards and always using original devices.

These devices must be used and installed in strict compliance with the instructions supplied by the manufacturer, who cannot be held liable for any damages deriving from improper or unreasonable use.

The manufacturer declines all forms of liability with regard to any errors possibly written in this handbook and reserves the right to add any modifications considered necessary at any time without notice.

NOTE
NOTES
REMARQUES
ANMERKUNGEN
NOTAS

INSTALLATORE
INSTALLER
INSTALLATEUR
INSTALLATEUR
INSTALATOR

BFT S.P.A.
Via Lago di Vico 44, 36015 Schio (VI) - *Italy*
tel. +39 0445 69 65 11 / fax. +39 0445 69 65 22
www.bft.it / e-mail: info@bft.it

AUTOMATISMES BFT FRANCE
13 Bd. E. Michelet, 69008 Lyon - *France*
tel. +33 (0)4 78 76 09 88 - fax +33 (0)4 78 76 92 23
e-mail: contacts@automatismes-bft-france.fr



BFT Torantriebssysteme GmbH
Faber-Castell-Straße 29
D - 90522 Oberasbach - *Germany*
tel. +49 (0)911 766 00 90 - fax +49 (0)911 766 00 99
e-mail: service@bft-torantriebe.de

BFT Automation UK Ltd
Unit 8E, Newby Road
Industrial Estate Hazel Grove, Stockport,
Cheshire, SK7 5DA - *UK*
tel. +44 (0) 161 4560456 - fax +44 (0) 161 4569090
e-mail: info@bftautomation.co.uk

BFT BENELUX SA
Parc Industriel 1, Rue du commerce 12
1400 Nivelles - *Belgium*
tel. +32 (0)67 55 02 00 - fax +32 (0)67 55 02 01
e-mail: info@bftbenelux.be

BFT-ADRIA d.o.o.
Obrovac 39
51218 Dražice (Rijeka)
Hrvatska - *Croatia*
tel. +385 (0)51 502 640 - fax +385 (0)51 502 644
e-mail: info@bft.hr

BFT Polska Sp. z o.o.
ul. Lipowa 21
05-091 Zabki, *Polska*
tel. +48 22 814 12 22 - fax. +48 22 781 60 22
e-mail: biuro@bft.com.pl

BFT USA BFT U.S., Inc.
6100 Broken Sound Pkwy. N.W., Suite 14
Boca Raton, FL 33487 - *U.S.A.*
T: +1 561.995.8155 - F: +1 561.995.8160
TOLL FREE 1.877.995.8155 - info.bft@bft-usa.com

BFT GROUP ITALIBERICA DE AUTOMATISMOS S.L.

Pol. Palou Nord,
Sector F - C/Cami - Can Basa nº 6-8 08401 Granollers -
(Barcelona) - Spain
tel. +34 938 61 48 28 - fax +34 938 70 03 94
e-mail: bftbcn@bftautomatismos.com

Pl. Comendador - C/
informática, Nave 22 - 19200 Azuqueca de henares
(Guadalajara) - Spain
tel. +34 949 26 32 00 - fax +34 949 26 24 51
e-mail: administracion@bftautomatismos.com

BFT SA-COMERCIO DE AUTOMATISMOS E MATERIAL DE SEGURANÇA
Urbanizaçao da Pedrulha Lote 9 - Apartado 8123,
3020-305 COIMBRA - *PORTUGAL*
tel. +351 239 082 790 - fax +351 239 082 799
e-mail: geral@bftportugal.com