

CONTROL PANEL FOR 230 V GEARMOTORS



FA00385-EN



Official Partner



MILANO 2015

FEEDING THE PLANET
ENERGY FOR LIFE

INSTALLATION MANUAL

ZM3E - ZM3EC - ZM3EP

EN English

IMPORTANT SAFETY INSTRUCTIONS WHEN INSTALLING
WARNING! IMPROPER INSTALLATION MAY RESULT IN SERIOUS DAMAGE, FOLLOW ALL INSTALLATION INSTRUCTIONS
THIS MANUAL IS EXCLUSIVELY INTENDED FOR PROFESSIONAL, SKILLED STAFF



LEGEND

- This symbol shows which parts to read carefully.
- This symbol shows which parts describe safety issues
- This symbol shows which parts to tell users about.

REFERENCE REGULATIONS

Came S.p.A. is certified for the: ISO 9001 quality and ISO 14001 environmental management systems.
 This product complies with the current regulations mentioned in the declaration of conformity.

DESCRIPTION

ZM3E - ZM3EP Multifunction control panel for two-leaved swing doors, with graphic programming display and signaling, plus self-diagnosing safety devices.

ZM3EC Multifunction control panel for two-leaved swing doors, complete with safety lock and buttons, with graphic programming display and signaling, plus self-diagnosing safety devices.

The functions on the input and output contacts, the time settings and user management, are set and viewed on the graphic display.

Set up to connect to the GP1 module for reduced consumption.

All connections are quick-fuse protected.

Intended use

Control panel	Gearmotor
ZM3E	ATI - AXO - FAST - FERNI - FROG - KRONO
ZM3EC	CBX - F4000 - F4000E
ZM3EP	FROG PLUS

Any installation and/or use other than that specified in this manual is forbidden.

Technical data

Type	ZM3E - ZM3EC	ZM3EP
Protection rating (IP)	54	54
Power supply (V - 50/60 Hz)	230 AC	230 AC
Maximum power of the 24 V (W) accessories	35	35
Stand-by consumption (W)	4.70	4.70
Consumption with Green Power (W)	0.75	-
Maximum power (W)	750	2400
Operating temperature (°C)	-20 ÷ +55	-20 ÷ +55
Material	ABS	ABS
Insulation class	II	II

Fuses	ZM3E - ZM3EC	ZM3EP
LINE-FUSE - Line	5 A-F	10 A-F
CONTROL BOARD - Card	1 A-F	630 mA-F
ACCESSORIES - Accessories	1.6 A-F	1,6 A-F
E.LOCK - Electrolock	3.15 A-F	3,15 A-F

Dimensions (mm)

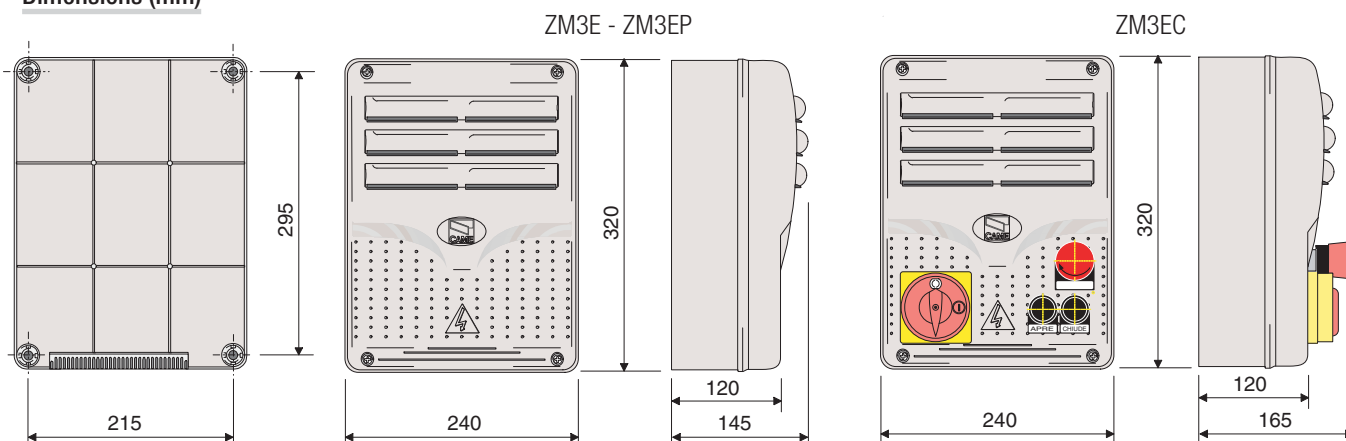

Description of parts

1. Transformer
2. M1 gearmotor condenser (black cables)
3. M2 gearmotor condenser (red cables)
4. Control board fuse
5. Accessories fuse
6. Terminals for the GP1 module
7. Electrolock fuse
8. Display
9. Display brightness adjusting trimmer
10. Memory roll board connector
11. Programming buttons
12. Power supply on warning LED
13. Programming warning LED
14. Connector for the R700 / R800 card
15. AF card connector
16. Keypad selector terminal
17. Antenna terminal
18. Terminals for second channel output
19. Endstop terminals
20. Terminals for transponder devices
21. Terminals for control and safety devices
22. Encoder terminals
23. Terminal board for microswitches
24. CRP connection terminals
25. RSE board connector
26. Power supply terminals
27. Line fuse
28. STOP button
29. CLOSING button
30. OPENING button
31. Safety lock

} ZM3EC

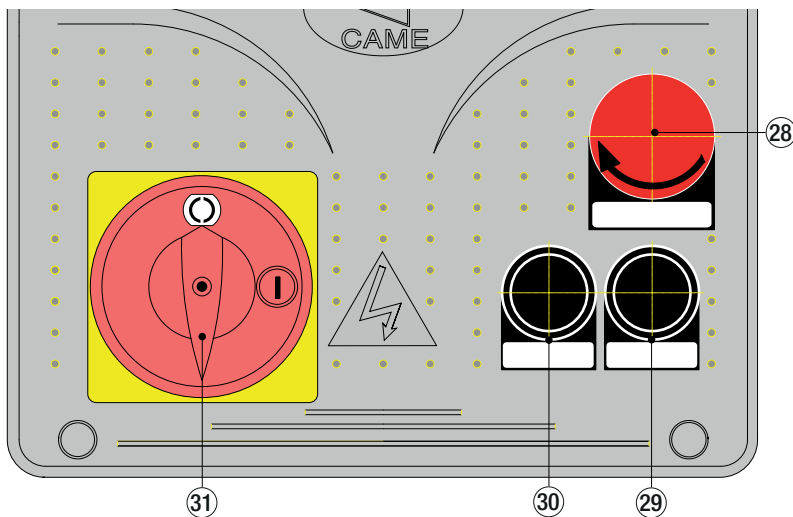
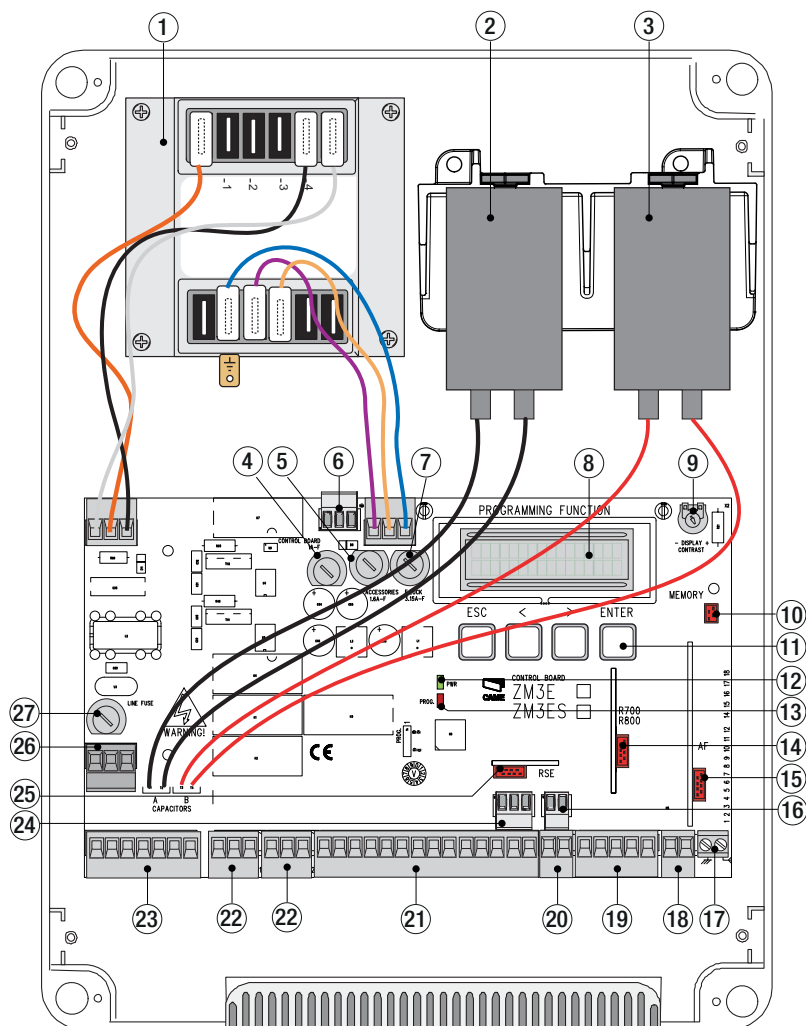

GENERAL INSTRUCTIONS FOR INSTALLING

- ⚠ Only skilled, qualified staff must install this product.
- ⚠ Before working on the control panel, cut off the main current supply and, if present, remove any batteries.

Preliminary checks

- ⚠ Before installing the control panel it is necessary to:
 - make sure that the point where the control panel is fastened is protected from any impacts and that the anchoring surface is solid enough, and that proper tools are used (that is, screws, anchors, and so on);
 - make sure you have set up a suitable dual pole cut off device along the power supply that is compliant with the installation rules. It should completely cut off the power supply according to category III surcharge conditions (that is, with minimum contact openings of 3 mm);
 - ⊕ Make sure that any connections inside the container (ones that ensure continuity to the protection circuit) are fitted with additional insulation with respect to those of other electrical parts inside.

Tools and materials

Make sure you have all the tools and materials you will need for installing in total safety and in compliance with applicable regulations. The figure shows some of the equipment installers will need.



Cable types and minimum thicknesses

Connection	Cable type	Cable length 1 < 15 m	Cable length 15 < 30 m
Control panel power supply 230 V AC	H05RN-F	3G x 1,5 mm ²	3G x 2,5 mm ²
Power supply to motor 230 V AC		4G x 1,5 mm ²	4G x 2,5 mm ²
Flashing light 230 V AC	FROR CEI 20-22 CEI EN 50267-2-1	2 x 0,5 mm ²	
Photocell transmitters		2 x 0,5 mm ²	
Photocell receivers		4 x 0,5 mm ²	
Command and safety device		2 x 0,5 mm ²	
Antenna	RG58	max 10 m	
Encoder	2402C 22AWG	max 30 m	
Paired connection or CRP	UTP CAT5	max 1000 m	

If cable lengths differ from those specified in the table, establish the cable sections depending on the actual power draw of the connected devices and according to the provisions of regulation CEI EN 60204-1.

For multiple, sequential loads along the same line, the dimensions on the table need to be recalculated according to the actual power draw and distances. For connecting products that are not contemplated in this manual, see the literature accompanying said products.

INSTALLATION

Fasten the control panel in a protected area using suitable screws, anchors and braces.

Drill through the pre-perforated holes and fit the cable gland with corrugated pipes for passing through the electric cables.

Pre-perforated hole diameter: 20 mm.

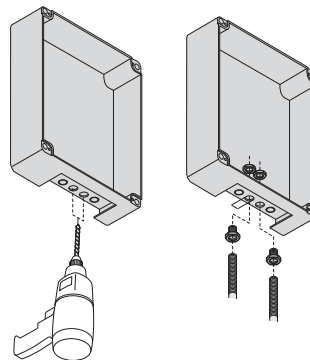
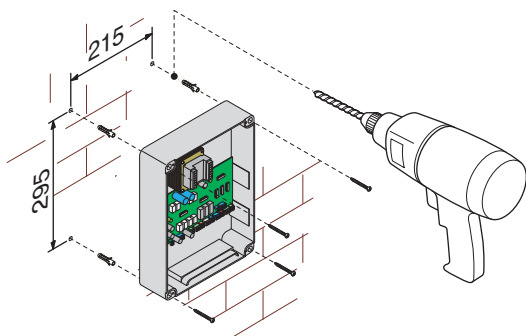

Assemble the pressure hinges.

Fit the hinge into the box (either on the right or left) and fasten them using the supplied screws and washers.

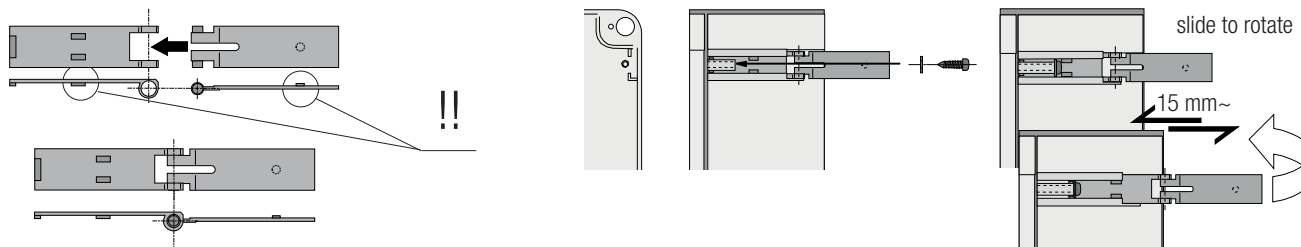

Snap the cover onto the hinges. Close it and secure it using the supplied screws.

After the settings and adjustments, fasten the cover using the supplied screws.

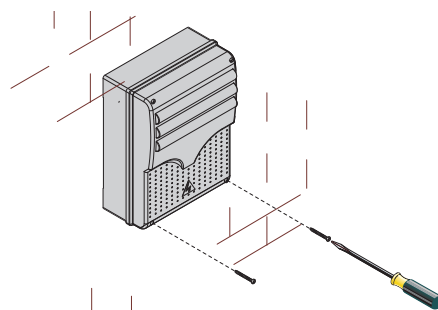
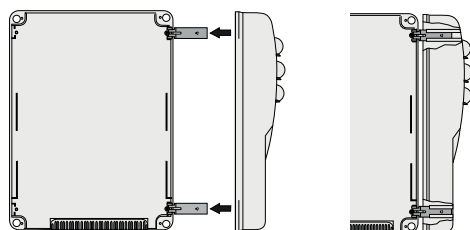

ELECTRICAL CONNECTIONS

Power supply to accessories

Terminal board for 24 V AC / DC accessories -
Maximum power: 20 W

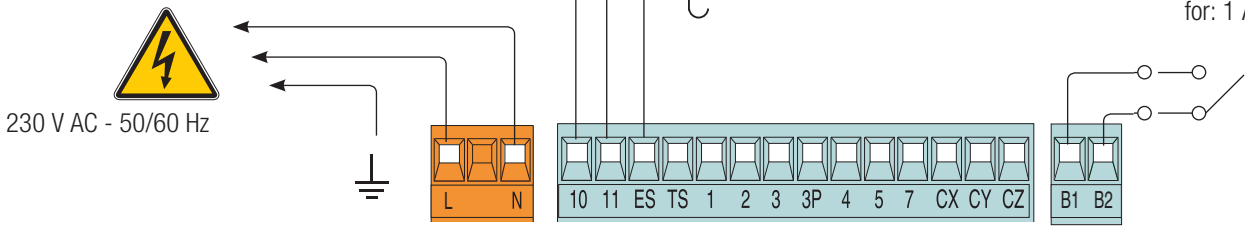

Connecting the gearmotors that have no limit switch

M1 - 230 V AC gearmotor with
delayed opening.

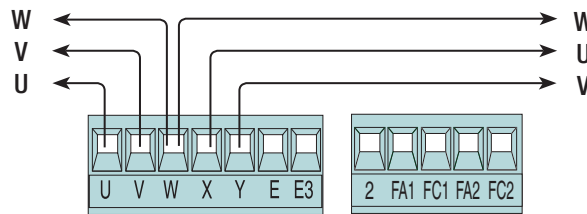

M2 - 230 V AC gearmotor with
delayed closing.

Connecting the gearmotors with endstops

M1 - 230 V AC
gearmotor with
delayed opening.

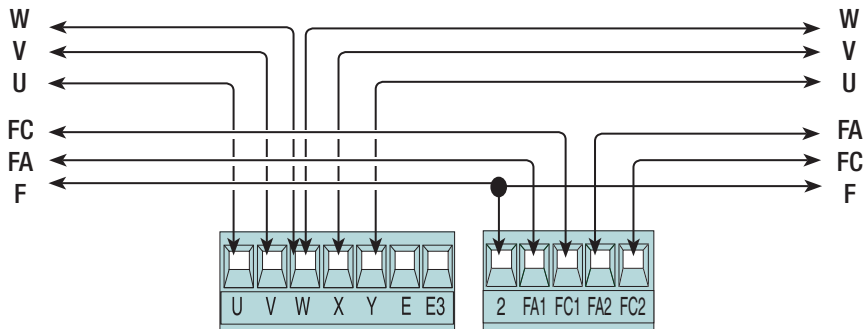

M2 - 230 V AC
gearmotor with
delayed closing.

Connecting the encoder gearmotors

M1 - 230 V AC gearmotor with
delayed opening.

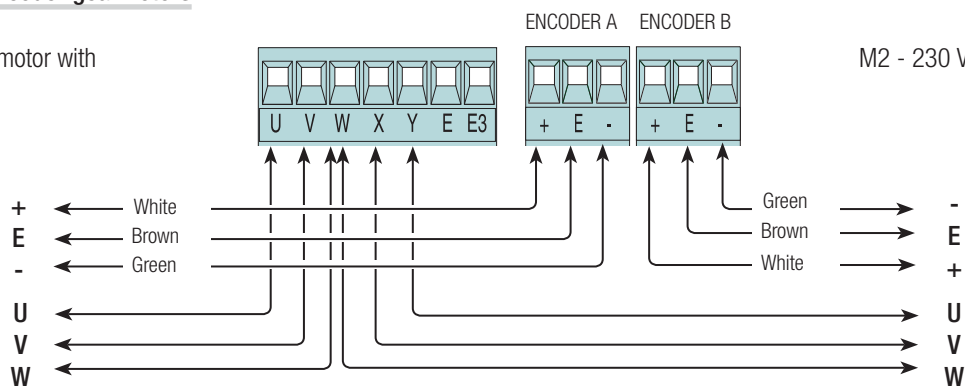

M2 - 230 V AC gearmotor with
delayed closing.

Motor torque limiter

To switch the motor torque, fit the example Faston terminal to one of four settings: 1 min. - 4 max.

Whereas on ZM3EP-series control panels, only fit the Faston terminal to settings 3 or 4.

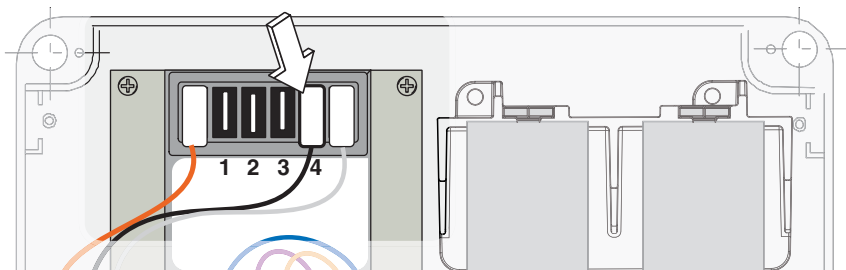

Command and control devices

⚠ Before fitting any snap-in cards (such as the AF or R700), YOU MUST CUT OFF THE POWER MAINS, and disconnect the power mains.

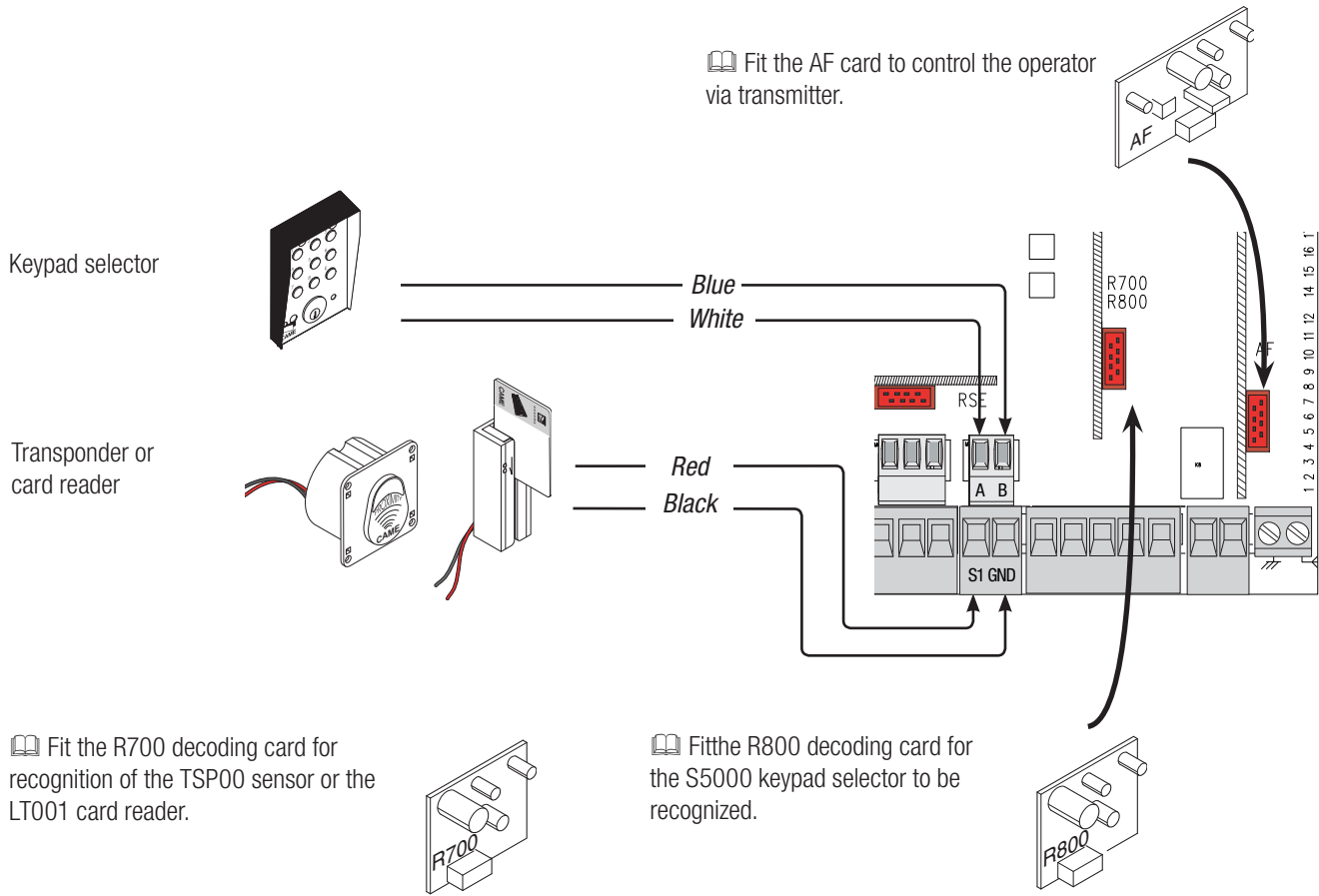

Stop button (NC contact). For stopping the gate leaves while excluding automatic closing. To resume movement press the control button or use another control device.

📖 If unused, select **[Disabled]** from the **[Total Stop]** function in the **[FUNCTIONS]** menu.

OPEN ONLY function from control device with NO contact.

PARTIAL or PEDESTRIAN OPENING function from a control device (NO contact).
See the **[2-3P command]** in **[FUNCTIONS]**.

ONLY CLOSE function from control device (NO contact).

OPEN-STOP-CLOSE-STOP sequential function / OPEN-CLOSE-INVERT step-step from a control device (NO contact).
See the **[2-7 command]** in **[FUNCTIONS]**.

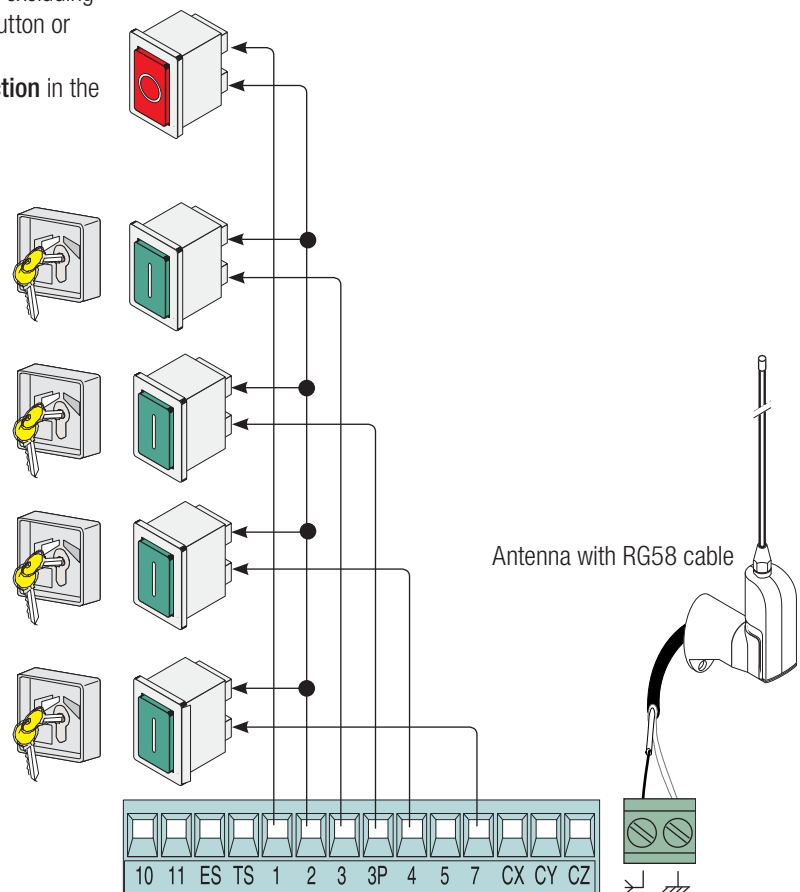

Signaling devices

Cycle or courtesy light (contact rating: 230 V - 60 W max). Auxiliary connection of an outdoor light which can be positioned where you like, to increase lighting in the driveway/parking area. Cycle: it stays lit from the moment that the gate leaf starts opening until it is completely closed (including the automatic closing time). Courtesy: it stays on for a fixed time of five minutes. See **[Light E]** in **[FUNCTIONS]**.

Movement flashing light (contact rating: 230 V - 25 W max). Flashes when the gate is opening and closing.

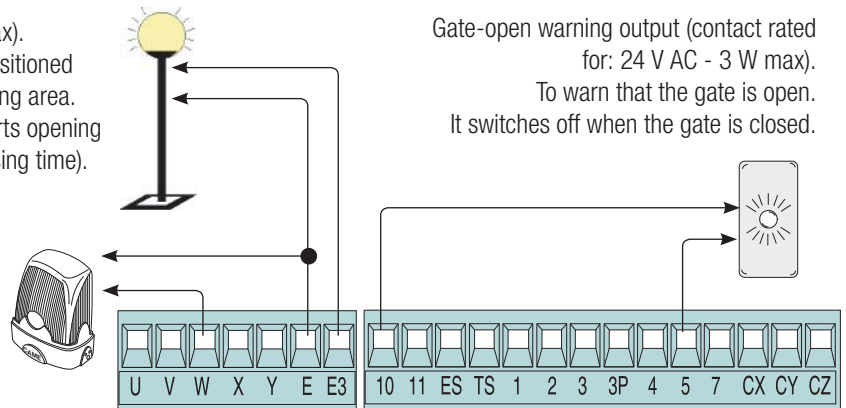

Safety devices

Photocells

Configure contact CX, CY or CZ (NC), input for EN 12978 safety devices like photocells. See **[CX input]**, **[CY input]** or **[CZ input]** functions.

- C1 reopening during closing. When the gate leaves are closing, opening the contact causes their movement to invert, until they are fully opened;

- C2 closing during opening. When the gate leaves are opening, opening the contact causes their movement to invert, until they are fully closed;

- C3 partial stop. Stops the gate leaves, if they are moving, and turns on automatic closing (if the automatic closing function is on);

- C4 obstruction wait. Stops the gate leaves, and resumes their movement once the obstruction is removed.

📖 If unused, contacts CX, CY and CZ should be disabled during programming.

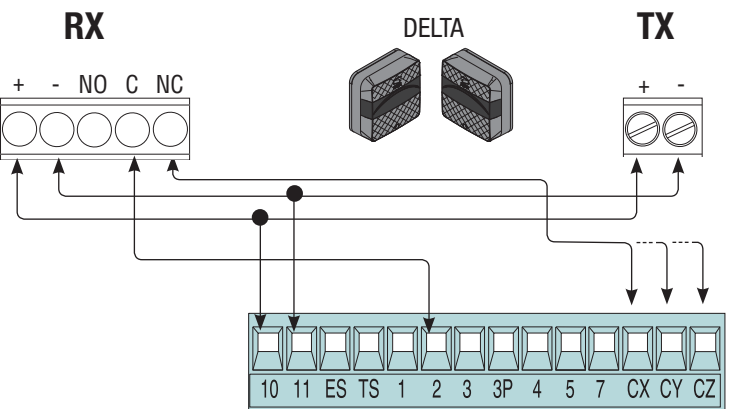
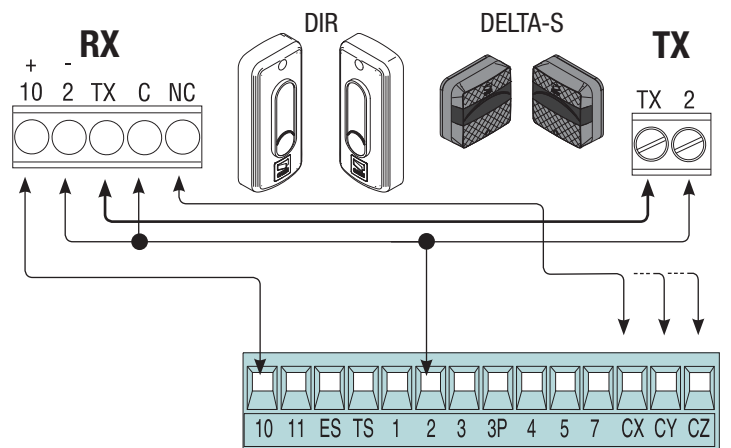

Sensitive Safety Edges

Configure contact CX, CY or CZ (NC), input for EN 12978 safety devices such as sensitive safety-edges. See the **[CX input]**, **[CY input]** or **[CZ input]** functions.

- C7 reopening during closing. When the gate leaves are closing, opening the contact causes their movement to invert, until they are fully opened;

- C8 reclosing during opening. When the gate leaves are opening, opening the contact inverts their movement until they are fully closed.

📖 If unused, contacts CX, CY and CZ should be disabled during programming.

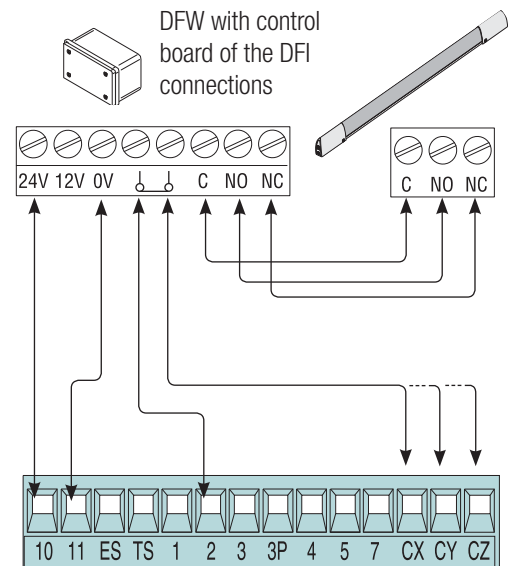
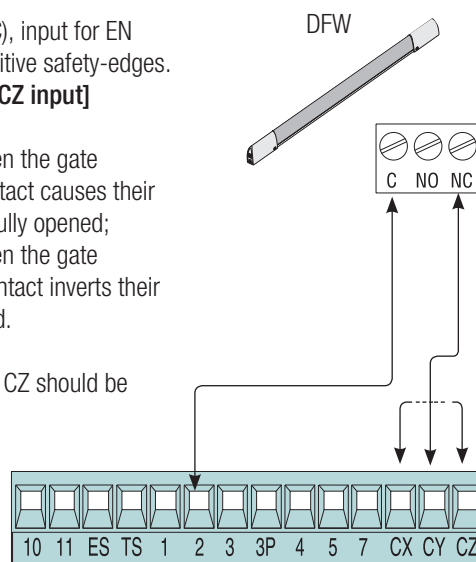

Connecting the safety devices, that is, safety test, or Sleep Mode

With the safety test connection, at each opening or closing command, the card checks the efficiency of the safety devices, such as, the photocells. Any anomalies will inhibit all commands.

Select from the **[Safety Test]** which of inputs CX, CY or CZ to turn on.

Whereas with the sleep mode function, energy consumption is reduced when the photocells are on stand-by.

Activate the Sleep **Mode** function from the **[FUNCTIONS]** menu.

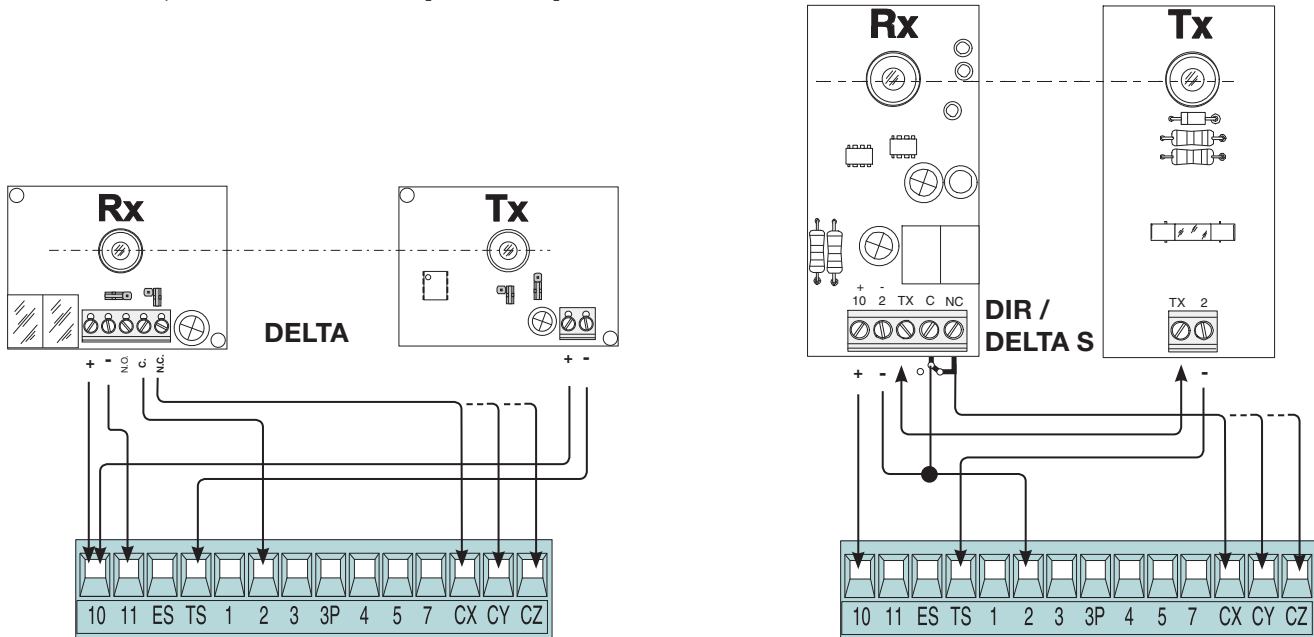

Connection with Came Remote Protocol (CRP)

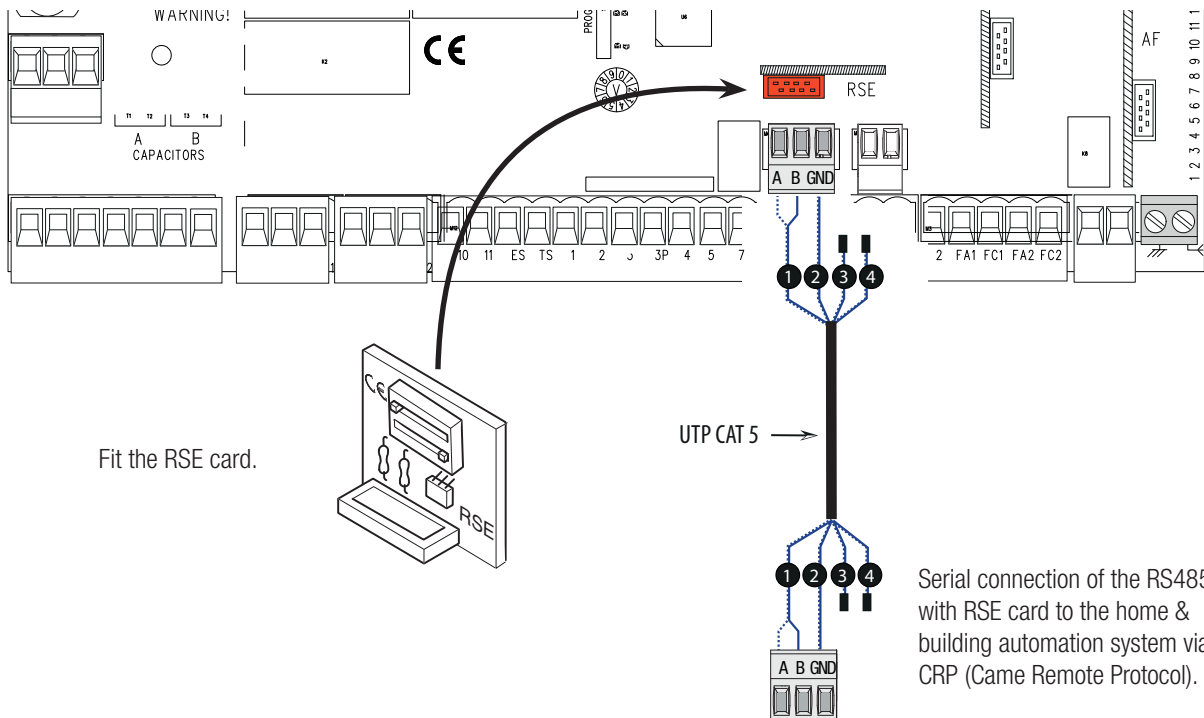

Description of programming commands

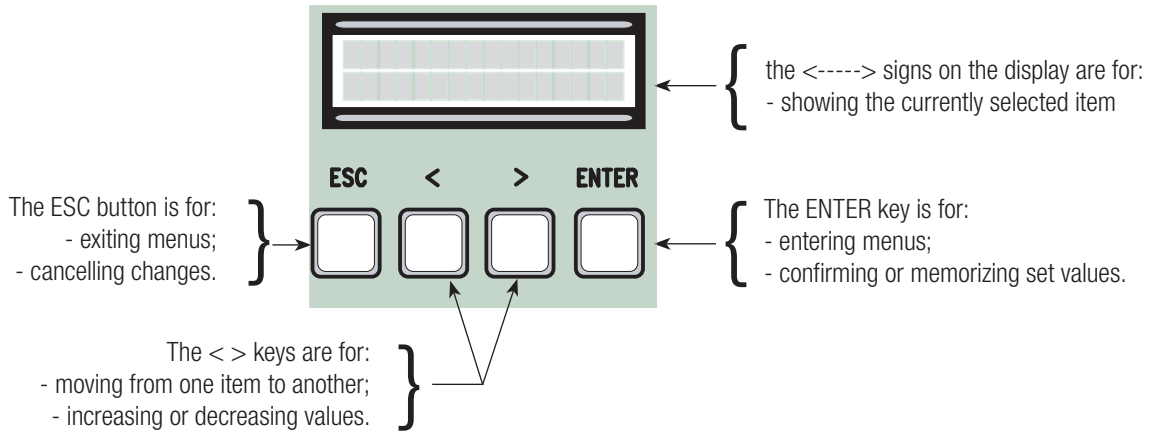

ENTER
To enter the menu, keep the ENTER button pressed for at least one second.

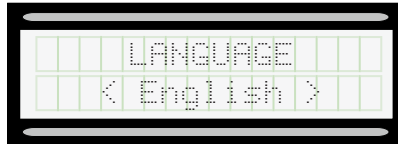

< >
To select menu items, use the arrow keys ...

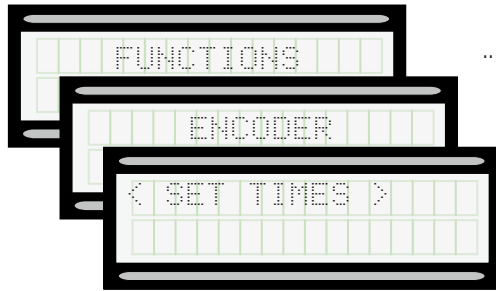

.. then press ENTER



< >
also for the submenus, use the arrow keys to select ...

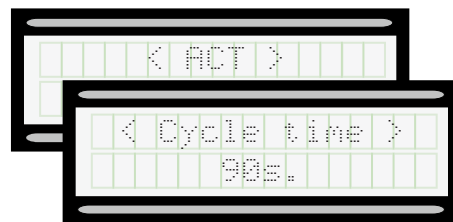

.. then press ENTER

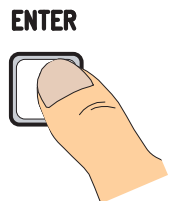

If the < > arrows are set to the **[Cycle time]**, you may edit their value.

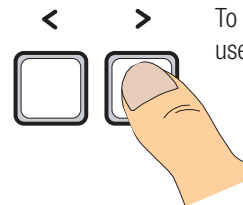

... the press ENTER to confirm ...



... to exit the menu wait 30 seconds, or press ESC, until the start up screen appears.

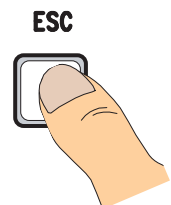

Meaning of the menu items abbreviations

[Partial open]	Partial Opening
[Maint Action]	Maintained Action
[Auto Close]	AutoClose
[Config]	Configuration
[CRP]	Came Remote Protocol
[Assoc Function]	Associated Feature
[M1 Open Accel]	M1 Opening approach as a percentage
[M1 Close Accel]	M1 Closing approach as a percentage
[M1 Opn Slw Dwn]	M1 Opening slow-down as a percentage
[M1 Cls Slw Dwn]	M1 Closing slow-down as a percentage
[M2 Open Accel]	M2 Opening approach as a percentage
[M2 Close Accel]	M2 Closing approach as a percentage
[M2 Opn Slw Dwn]	M2 Opening slowdown as a percentage
[M2 Cls Slw Dwn]	M2's Closing Slowdown as a percentage
[Change Code]	Mod. name
[Start message]	Starting message
[No. of motors]	Motor number
[Enc Slow Down]	Opening and closing slow-downs with ENCODER
[Obstruc Detct]	Obstacle Detection
[Delete user]	Remove User
[Opening Delay M1]	Closing Delay M1
[Closing Delay M2]	M2 Closing Delay
[Travel sens]	Gate Run Sensibility
[Slw Dwn sens]	Sensib. Decel
[Closing thrust]	Closing thrust
[Ram jolt time]	Ram-jolt Time
[Preflash time]	Preflashing Time
[Slow down time]	Slow-down Time
[Lock time]	Lock Time
[ACT]	Automatic Closing Time
[Pedestrian ACT]	Pedestrian Automatic Closing Time
[Slow dwn speed]	Slow-down Speed

Menu map

[LANGUAGE]		Default
	[Italiano] / [English] / [Français] / [Deutsch] / [Español] / [Portugues euro]/[Portugues bras]	Italiano
[FUNCTIONS]		Default
[Auto Close]	[Disabled] / [Enabled]	[Enabled]
[Maint Action]	[Disabled] / [Enabled] / [Closing]	[Disabled]
[Obstruc Detct]	[Disabled] / [Enabled]	[Disabled]
[Safety Test]	[Disabled] / [CX] / [CY] / [CZ] / [CX+CY] / [CX+CZ] / [CY+CZ] / [CX+CY+CZ]	[Disabled]
[Preflashing]	[Disabled] / [Enabled]	[Disabled]
[Ram Jolt]	[Disabled] / [Closing] / [Opening] / [Open-Close]	[Disabled]
[Total Stop]	[Disabled] / [Enabled]	[Enabled]
[CX input]	[Disabled] / [C1] / [C2] / [C2] / [C4] / [C7] / [C8]	[C1]
[CY input]	[Disabled] / [C1] / [C2] / [C2] / [C4] / [C7] / [C8]	[C3]
[CZ input]	[Disabled] / [C1] / [C2] / [C2] / [C4] / [C7] / [C8]	[Disabled]
[Closing thrust]	[Disabled] / [Enabled]	[Disabled]
[Lock]	[Disabled] / [Closing] / [Opening] / [Open-Close]	[Disabled]
[Config]	[Time Lmt Swtch] / [End Stop] / [Slow Down] / [Op LS-CI Sl Dn] / [ENCODER]	[ENCODER]
[End Stop]	[N.C. / N.O.]	[N.C.]
[2-7 command]	[Open-Close] / [Op. Stop Cl.]	[Open-Close]
[2-3P command]	[Partial] / [Pedestrian]	[Pedestrian]
[E Light]	[Courtesy] / [Cycle]	[Cycle]
[B1-B2 output]	[Monostable] / [Bistable]	[Bistable]
[Slow dwn speed]		
[No. of motors]	[M1+M2] / [M2];	[M1+M2]
[Motor type]	[FROG] / [AXO] / [FAST] / [FERNI] / [FROG PLUS]	[FROG]
[Sleep mode]	[Disabled] / [Enabled]	[Disabled]
[CRP address]	[1] ⇔ [32]	
[CRP baudrate]	[1200] / [2400] / [4800] / [9600] / [19200] / [38400] / [57600] / [115200]	[38400]

[ENCODER]		Default
[Sensitivity]	[Enabled] / [Disabled]	[Enabled]
[Travel sens]		[-●○○○○○○○○○○○○○+]
[Slw Dwn sens]		[-●○○○○○○○○○○○○○+]
[Enc Slow Down]	[ON] / [OFF]	[ON]
[M1 Opn Slw Dwn]	[1%] ⇔ [60%]	[10%]
[M1 Cls Slw Dwn]	[1%] ⇔ [60%]	[10%]
[M2 Opn Slw Dwn]	[1%] ⇔ [60%]	[10%]
[M2 Cls Slw Dwn]	[1%] ⇔ [60%]	[10%]
[M1 Close Accel]	[1%] ⇔ [15%]	[15%]
[M2 Close Accel]	[1%] ⇔ [15%]	[15%]
[M1 Open Accel]	[1%] ⇔ [15%]	[15%]
[M2 Open Accel]	[1%] ⇔ [15%]	[15%]
[Travel calibr]	[Confirm? (No)] / [Confirm? (Yes)]	[15%]

[SET TIMES]		Default
[ACT]	[0 s] ⇔ [300 s]	[10 s]
[Pedestrian ACT]	[0 s] ⇔ [300 s]	[10 s]
[Cycle time]	[10 s] ⇔ [150 s]	[90 s]
[Opening Delay M1]	[0 s] ⇔ [10 s]	[2 s]
[Closing Delay M2]	[0 s] ⇔ [60 s]	[2 s]
[Preflash time]	[one second] ⇔ [60 s]	[5 s]
[Lock time]	[one second] ⇔ [5 s]	[2 s]
[Ram jolt time]	[one second] ⇔ [10 s]	[one second]
[Partial open]	[5 s] ⇔ [60 s]	[10 s]
[Slow down time]	[OFF] ⇔ [30 s]	[5 s]

[USERS]		Default
[Add User] (250max)		
[Change Name]		
[Change Code]		
[Assoc Function]	[2-7] / [Open] / [B1-B2] / [2-3P] / [Disabled];	
[Delete user]		
[Delete ALL]	[Confirm? (No)] / [Confirm? (Yes)]	
[SENSOR]	[Keypad] / [Transponder]	[Keypad]
[Save memory]	[Confirm? (No)] / [Confirm? (Yes)]	
[Load memory]	[Confirm? (No)] / [Confirm? (Yes)]	

[INFO]
[Version] / [No. of travels] / [Start message] / [Reset system]

[MOTORS TEST]
[<=M1 M2=>]

IMPORTANT! Iniziare la programmazione eseguendo per prime le funzioni [MOTOR TYPE],[NO. OF MOTORS], [TOTAL Button] and [TRAVEL CALIBR] function.

Language menu

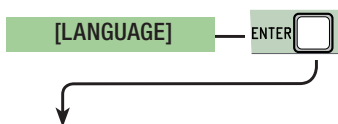

[Italiano] / [English] / [Français] / [Deutsch] / [Español] / [Portugues euro] / [Portugues bras]
Select one of the available languages

Functions menu

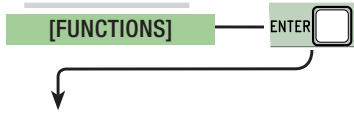





[Auto Close] [Disabled] / [Enabled]	
The first automatic-closing wait starts when the opening endstop point is reached and can be set to between 0 and 300 s. The automatic closing does not turn on if any of the safety devices trigger when an obstruction is detected, after a total stop or during a power outage.	
[Maint Action]	[Disabled] / [Enabled] / [Closing]
The gate leaves close by keeping a button pressed. Opening button on contact 2-3 and closing button on contact 2-4. All other control devices, even radio-based ones, are excluded.	
[Obstruc Dect]	[Disabled] / [Enabled]
With the gate-leaves closed, open or after a total stop, the operator stays idle if the safety devices (photocells and sensitive safety-edges) detect an obstruction.	
[Safety Test]	[Disabled] / [CX] / [CY] / [CZ] / [CX+CY] / [CX+CZ] / [CY+CZ] / [CX+CY+CZ]
After every opening or closing command, the board will check whether the photocells are working properly.	
[Preflashing]	[Disabled] / [Enabled]
After an opening or closing command, the flashing connected onto W-E flashes before starting the maneuver. To set the time, see [Preflashing T] in the [ADJUST TIMES] menu.	
[Ram Jolt]	[Disabled] / [Closing] / [Opening] / [Open-Close]
Before any opening and closing maneuver, the gate leaves thrust inward to help release the electro-lock. To adjust this thrust time, select [Ram hit time] in the [ADJUST TIMES] menu.	
[Total Stop]	[Enabled] / [Disabled]
NC input - Gate-leaves stop with automatic closing excluded; to resume movement, use the control device. The safety device is inserted into 1-2.	
[CX input]	[Disabled] / [C1] / [C2] / [C3] / [C4] / [C7] / [C8]
NC input – Can associate: C1 = reopening during closing by photocells, C2 = reclosing during opening by photocells, C3 = partial stop, C4 = obstruction wait, C7 = reopening during closing by sensitive safety-edges, C8 = reclosing during opening by sensitive safety-edges.	
[CY input]	[Disabled] / [C1] / [C2] / [C3] / [C4] / [C7] / [C8]
NC input – Can associate: C1 = reopening during closing by photocells, C2 = reclosing during opening by photocells, C3 = partial stop, C4 = obstruction wait, C7 = reopening during closing by sensitive safety-edges, C8 = reclosing during opening by sensitive safety-edges.	
[CZ input]	[Disabled] / [C1] / [C2] / [C3] / [C4] / [C7] / [C8]
NC input – Can associate: C1 = reopening during closing by photocells, C2 = reclosing during opening by photocells, C3 = partial stop, C4 = obstruction wait, C7 = reopening during closing by sensitive safety-edges, C8 = reclosing during opening by sensitive safety-edges.	
[Closing thrust]	[Disabled] / [Enabled]
When the run reaches the endstop, the operator performs a closing thrust for a some seconds.	
[Lock]	[Disabled] / [Closing] / [Opening] / [Open-Close]
Set the electric lock, to lock the leaves, on any function chosen among those available.	
[Config]	[Slow Down] / [Op LS-CI SI Dn] / [ENCODER] / [Time Lmt Swtch] / [End Stop]
Configuring the opening and closing slow-downs	
[Slow Down]*	➔ opening and closing slow-downs.
[Op LS-CI SI Dn]*	➔ opening endstop and closing slow-down.
[ENCODER] menu	➔ slow-down management, obstruction detection and sensitivity.
[Time Lmt Swtch]	➔ timed endstop.
[End Stop]	➔ opening and closing endstop.
*slowdowns configurable with the [Slow down time] in the [SET TIMES]	
[End stop]	[N.C] / [N.O]
Configuring the endstops as normally opened or closed contacts.  This function only appears if option is selected between [End stop] , [Op LS-CI SI Dn] or [Slow Down] from the [Config] function.	
[2-7 command]	[Open-Close] / [Opn Stp Clse]
Configuration contact 2-7 in step-step (open-close) or sequential (open-stop-close-stop).	
[2-3P command]	[Pedestrian] / [Partial]
Configuring contact 2-3P to pedestrian opening (total opening of the second gate-leaf) or partial (partial opening of the second gate leaf) depending on the time set on [Partial open] in the [SET TIMES] menu.	

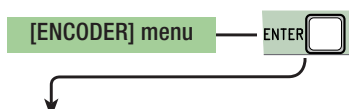

[E Light]	[Courtesy] / [Cycle]
Configuring the light connected to 10-E: - courtesy: freely positionable outdoor light, for increasing lighting in driveway/parking area. It stays on for a preset five minutes; - cycle: freely positionable outdoor light for increasing lighting in the driveway/parking area. It stays lit from the moment that the gate leaf starts opening until it is completely closed (including the automatic closing time). In case the automatic closing is not inserted, it stays on only during the movement.	
[B1-B2 output]	[Monostable] / [Bistable]
Configuring contact B1-B2 in Monostable or Bistable mode (switch).	
[Slow down speed]	[-●●●●●○○○○○+]
Setting the opening or closing or only closing slow-down speed if the slow-down is configured as [Op LS-CI SI Dn].	
[No. of motors]	[M1+M2] / [M2]
Setting the number of motors from one to two depending on how many gate-leaves the system has.	
[Motor type]	[FROG] / [AXO] / [FAST] / [FERNI] / [FROG PLUS]
Setting the type of operator for the swing gates on the system.	
[Sleep mode]	[Disabled] / [Enabled]
For the photocells to reduce energy consumption when in stand-by mode (with GP1 module connected).	
[CRP address]	[1] ⇔ [32]
With systems fitted with several operators and the CRP (Came Remote Protocol) system connection, set an address between 1 and 32 for each control panel.	
[CRP baudrate]	[1200] / [2400] / [4800] / [9600] / [19200] / [38400] / [57600] / [115200]
Setting the communication speed used in the CRP (Came Remote Protocol) connection system.	

ENCODER menu

 The [ENCODER] menu appears only when the [Config] is selected in the [FUNCTIONS] menu.



[Sensitivity]	[Enabled] / [Disabled]
Obstruction detection sensibility.	
[Travel sens]	[-●○○○○○○○○○○○+]
Obstruction detection sensitivity during gate run (both opening and closing).  You need to turn on the [Sensitivity] in the [ENCODER] menu.	
[Slw Dwn sens]	[-●○○○○○○○○○○○+]
Obstruction detection sensitivity during slow-down (both opening and closing).  You need to turn on the [Sensitivity] in the [ENCODER] menu.	
[Enc Slow Down]	[ON] / [OFF]
Activating the opening and closing slow-down starting points.	
[M1 Opn Slw Dwn]	[1%] ⇔ [60%]
Adjusting M1's slow-down starting point before the opening endstop. The slow-down starting point is calculated as a percentage (from 1% to 60% of the complete gate-leaf run).  This function only appears if the [Enc Slow Down] in the [ENCODER] menu.	
[M1 Cls Slw Dwn]	[1%] ⇔ [60%]
Adjusting M1's slow-down starting point before the closing endstop. The slow-down starting point is calculated as a percentage (from 1% to 60% of the complete gate-leaf run).  This function only appears if the [Enc Slow Down] in the [ENCODER] menu.	

[M2 Opn Slw Dwn]	[1%] ⇔ [60%]
Adjusting M2's slow-down starting point before the opening endstop. The slow-down starting point is calculated as a percentage (from 1% to 60% of the complete gate-leaf run).  This function only appears if the [Enc. Slwdwn.] function in the [ENCODER] menu.	
[M2 Cls Slw Dwn]	[1%] ⇔ [60%]
Adjusting M2's slow-down starting point before the closing endstop. The slow-down starting point is calculated as a percentage (from 1% to 60% of the complete gate-leaf run).  This function only appears if the [Enc. Slwdwn.] function in the [ENCODER] menu.	
[M1 Close Accel]	[1%] ⇔ [15%]
M1's approach starting point is calculated as a percentage (from 1% to 15% of the complete gate-leaf run) before the closing endstop.	
[M2 Close Accel]	[1%] ⇔ [15%]
M2's resting starting point is calculated as a percentage (from 1% to 15% of the complete gate-leaf run) before the closing endstop.	
[M1 Open Accel]	[1%] ⇔ [15%]
M1's approach starting point is calculated as a percentage (from 1% to 15% of the complete gate-leaf run) before the closing endstop.	
[M2 Open Accel]	[1%] ⇔ [15%]
M2's approach starting point is calculated as a percentage (from 1% to 15% of the complete gate-leaf run) before the opening endstop.	
[Travel calibr]	
Automatic calibration of the gate-leaf run (see the TRAVEL CALIBRATION paragraph).	

Time settings menu



[ACT]	[0 s] ⇔ [300 s]
The first automatic-closing wait starts when the opening endstop point is reached and can be set to between 0 and 300 s. The automatic closing does not turn on if any of the safety devices trigger when an obstruction is detected, after a total stop or during a power outage.	
[Pedestrian ACT]	[0 s] ⇔ [300 s]
Waiting time of M2's second leaf in the open position. Once this time elapses, a closing maneuver is automatically performed. The waiting time can be set to between 0 and 300 seconds.	
[Cycle time]	[10 s] ⇔ [150 s]
Gearmotor working time during opening and closing. The working time can be set to between 10 and 150 seconds.	
[Opening Delay M1]	[0 s] ⇔ [10 s]
M1 opening delay with respect to M2 after each opening command. The waiting time can be set to between 0 and 10 seconds.	
[Closing Delay M2]	[0 s] ⇔ [60 s]
M2's closing delay with respect to M1's closing after each closing command. The waiting time can be set to between 0 and 60 seconds.	
[Preflash time]	[1 s] ⇔ [60 s]
After an opening or closing command, the flashing light connected to W-E, flashes from between 1 and 60 seconds before starting the maneuver.	
[Lock time]	[1 s] ⇔ [5 s]
Intervention time for the electrolock to release after each opening command. The intervention time can be adjusted to between one second and five seconds.	
[Ram jolt time]	[1 s] ⇔ [10 s]
The closing and opening jolt thrust-time of the gearmotors after each command. The thrust time can be set to between one and three seconds.	
[Partial open]	[5 s] ⇔ [60 s]
M2's opening time. The time can be adjusted to between five seconds and 60 seconds.	
[Slow down time]	[OFF] ⇔ [30 s]
Leaf slow-down time before each end stop. The time can be set to between zero and 30 s.  This function appears only if the following slow downs are set, [Op LS-CI SI Dn] or [Time Lmt Swtch] from the [Config] function.	

Entering a new user

1. From the [USERS], select [Add User] function. Press ENTER to confirm.

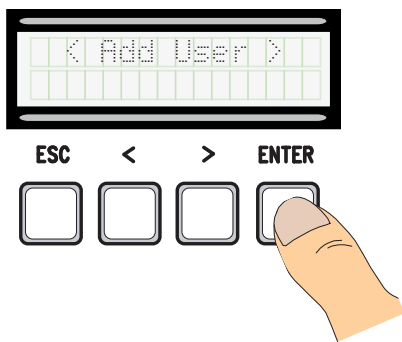

2. Select [Confirm? (Yes)] and press ENTER to confirm.

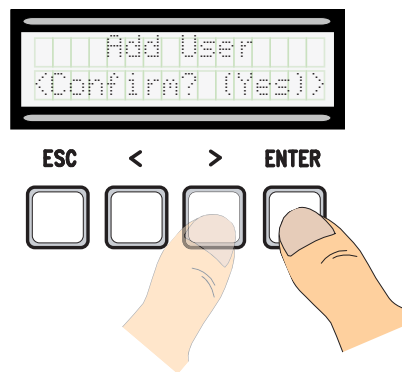

3. Select the function to associate to users. Press ENTER to confirm...

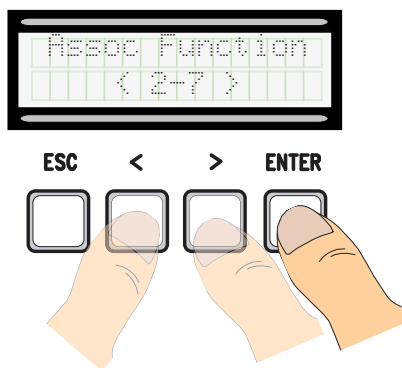

4. ... a code to enter will be requested. Send the code from the transmitter, with the swipe card or transponder.

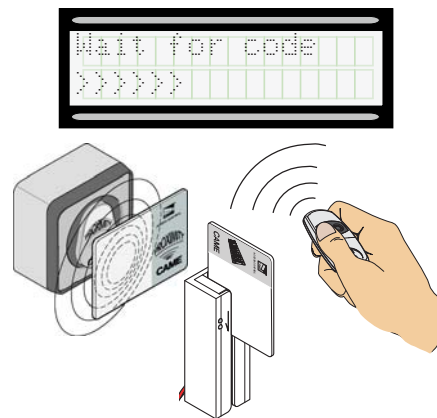

5. Once the code is entered, the user number will appear with the memorized number ...

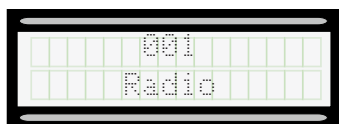

6. ... or, if the code is already entered, then [Existing code].



Modify user name

1. From the [USERS], select [Change Name]. Press ENTER to confirm

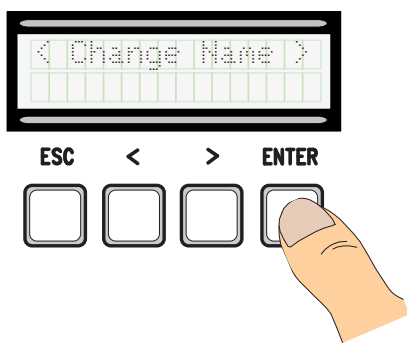

2. Select the user number or name to edit and press ENTER to confirm.

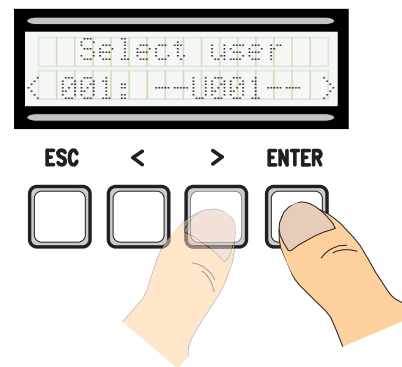

3. Use ENTER to move the cursor forward, ESC for moving the cursor backward and < > to select the letter of figure.

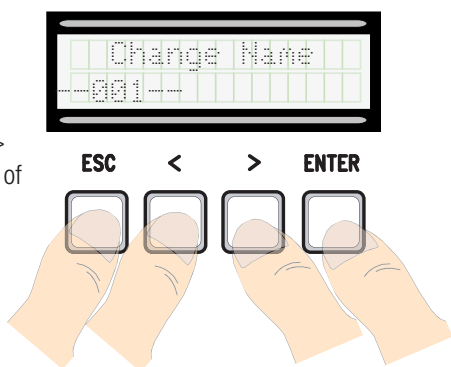

4. Press ENTER for a few seconds to confirm the text.

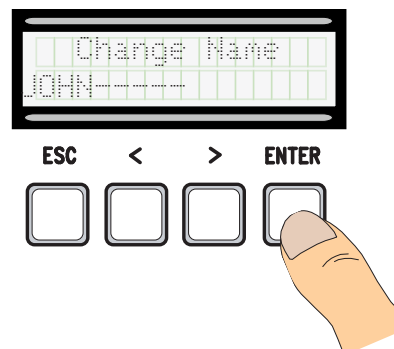

Modify code

1. From the **[USERS]**, select **[Change Code]**. Press ENTER to confirm

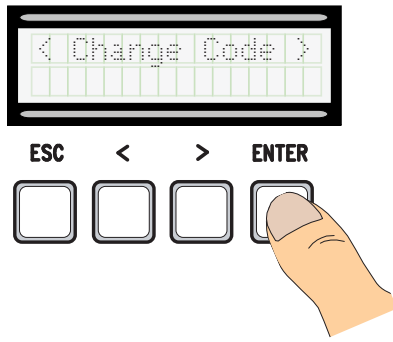

2. Select the user name of which you want to edit the code and press ENTER to confirm.

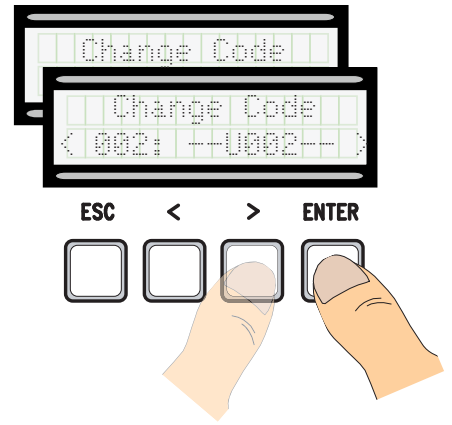

3. ... a code to enter will be requested. Send the code from the transmitter, with the swipe card or transponder.

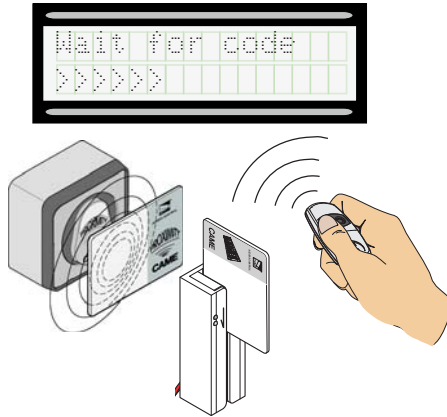

4. ... once the code is entered, the user number and type of memorized command will appear...

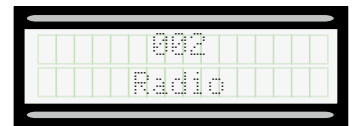

5. Select **[Confirm? (Yes)]** and press ENTER to confirm.



Function related to the user

1. From the **[USERS]**, select **[Assoc Function]**. Press ENTER to confirm

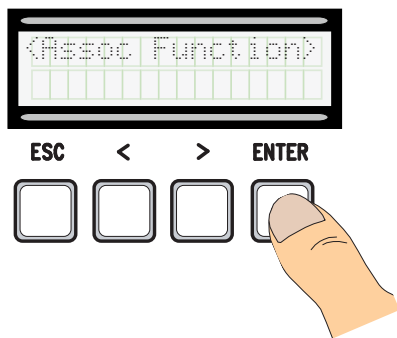

2. Select the user name for which you want to change the function and press ENTER to confirm.

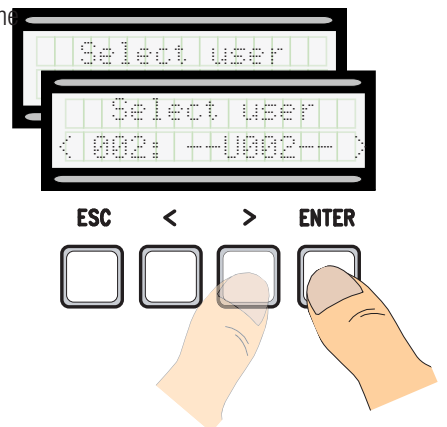

3. Select the new function to relate to the user. Press ENTER to confirm.

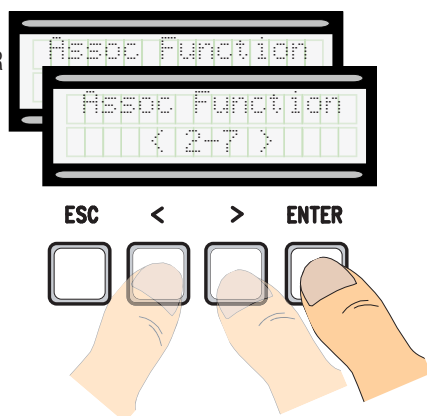

4. Select **[Confirm? (Yes)]** and press ENTER to confirm.

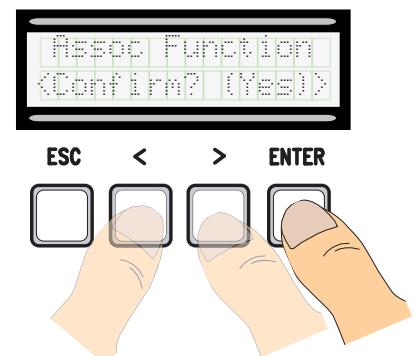

Travel calibration

⚠ Before calibrating the gate run, check that the maneuvering area is free from any obstruction and that there are both opening and closing mechanical stops.

⚠ The mechanical end-stops are obligatory.

Important! During the calibration, all safety devices will be disabled except for the PARTIAL STOP one.

1. From the [ENCODER] menu, select [Travel calibr]. Press ENTER to confirm

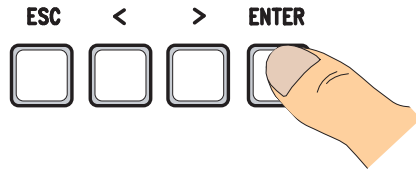

2. Select [Confirm? (Yes)] and press ENTER to confirm.

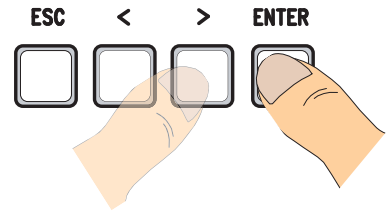

3. M1's gate leaf will perform a new closing until it completely stops...

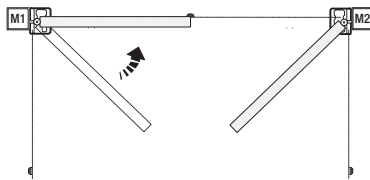

4. ...then, M2's gate leaf will perform the same closing...

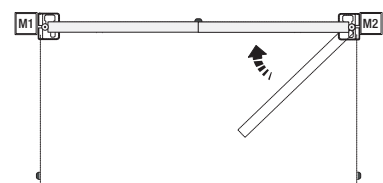
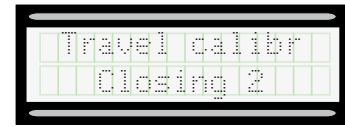

5. ... and then M2's gate leaf will perform a full opening...

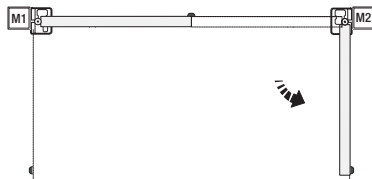

6. ... after which, M1's gate leaf will also perform a full opening.

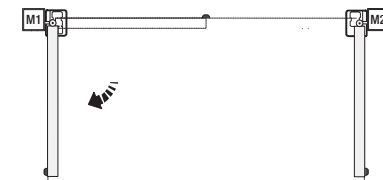
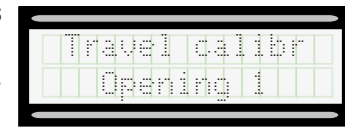

7. Once the procedure is completed, the display will read [Travel calibr OK] for a few seconds.



Memory Roll Card

For memorizing user and system configuration data, then using them on another control board.

📖 After memorizing the data, it is best to remove the Memory Roll card while the control board is in operation.

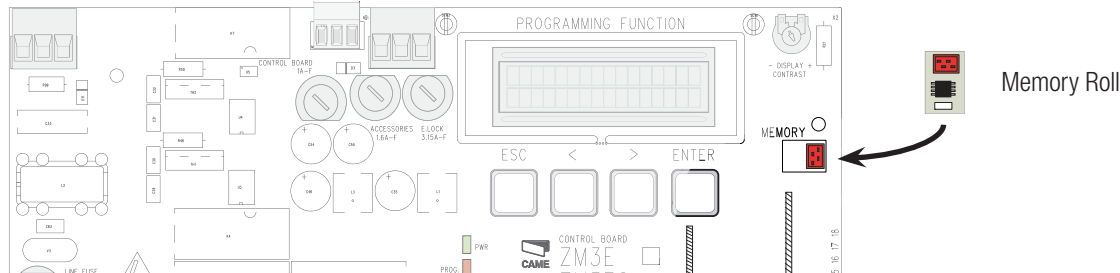

ERROR MESSAGE

📖 Error messages appear on the display.

[Encoder - ERROR], [Error!]	Broken encoder or wrong connection.
[Safety Test - ERROR]	Safety devices malfunctioning.
[End Stop - ERROR]	Malfunctioning endstop contacts
[Cycle time - ERROR]	Insufficient working time
[Safety - STOP], [C1], [C3], [C4], [C7] or [C8]	Malfunctioning safety devices or wrong connection

DIAGRAM OF THE SLOW-DOWN AND FINAL APPROACH POINTS AND FOR THE ENCODER DEVICE

The run area and slow down and approach points are tested according to the parameters set forth by Technical Standards EN 12455 and EN 12453 for compliance with the impact forces generated by the running leaves.

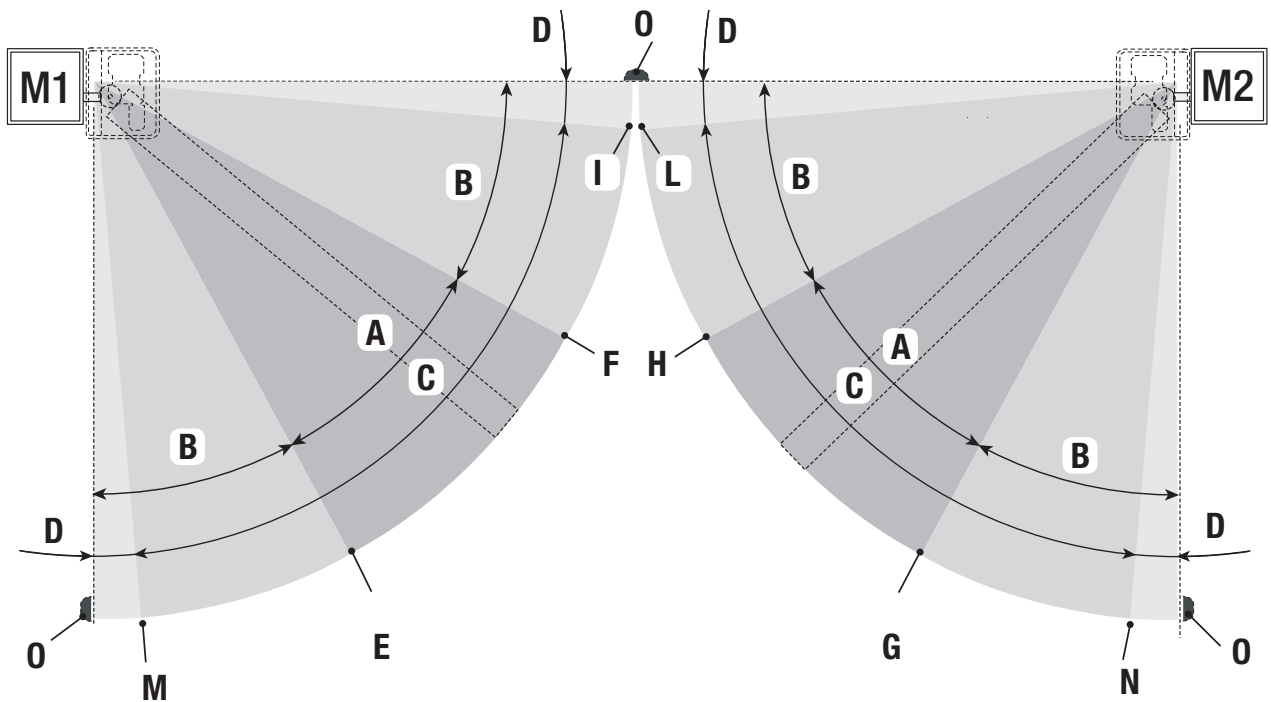

- A = Normal speed
- B* = Slowed-down speed
- C = Encoder intervention zone with movement inversion
- D = Encoder intervention zone with movement stopped
- E = Opening slow-down starting point [M1 Opn Slw Dwn]
- F = Closing slow-down starting point [M1 Cls Slw Dwn]
- G = Opening slow-down starting point [M2 Opn Slw Dwn]
- H = Closing slow-down starting point [M2 Cls Slw Dwn]
- I** = Closing approach starting point [M1 Close Accel]
- L** = Closing approach starting point [M2 Close Accel]
- M** = Opening deceleration point [M1 Open Accel]
- N** = Opening slow-down starting point [M2 Open Accel]
- O = Strike plates

* Minimum 600 mm from the strike plate.

** Set the final approach percentage for the function [M1 Close Accel] for M1 and [M2 Close Accel] for M2 from the [ENCODER] menu so as to obtain a distance of between 1 and 50 mm maximum from the final strike plate point.

DISMANTLING AND DISPOSAL

Always make sure you comply with local laws before dismantling and disposing of the product. The packaging materials (cardboard, plastic, and so on) should be disposed of as solid urban waste, and simply separated from other waste for recycling.

Whereas other components (control boards, batteries, transmitters, and so on) may contain hazardous pollutants. These must therefore be disposed of by authorized, certified professional services.

DO NOT DISPOSE OF IN NATURE!

DECLARATION OF CONFORMITY

CE Declaration - Came S.p.A. declares that this device conforms to the essential, pertinent requirements provided by directives 2004/108/EC and 2006/42/CE.

An original copy of the declaration of conformity is available on request.

English - Manual code: **FA00385-EN v. 1** - 02/2016 - © Came S.p.A.
The contents of this manual may be changed at any time without prior notice.

CAME
safety & comfort



Came S.p.A.

Via Martiri Della Libertà, 15

31030 **Dosson di Casier**
Treviso - Italy

📞 (+39) 0422 4940

📠 (+39) 0422 4941

Via Cornia, 1/b - 1/c

33079 **Sesto al Reghena**
Pordenone - Italy

📞 (+39) 0434 698111

📠 (+39) 0434 698434

www.came.com